

50W HF QCX Power Amplifier kit assembly manual

A low-cost, 50W Power Amplifier for the QCX with Full-break-in (QSK) solid state Tx/Rx switching

PCB Rev 2

Designed and produced by QRP Labs, 2019

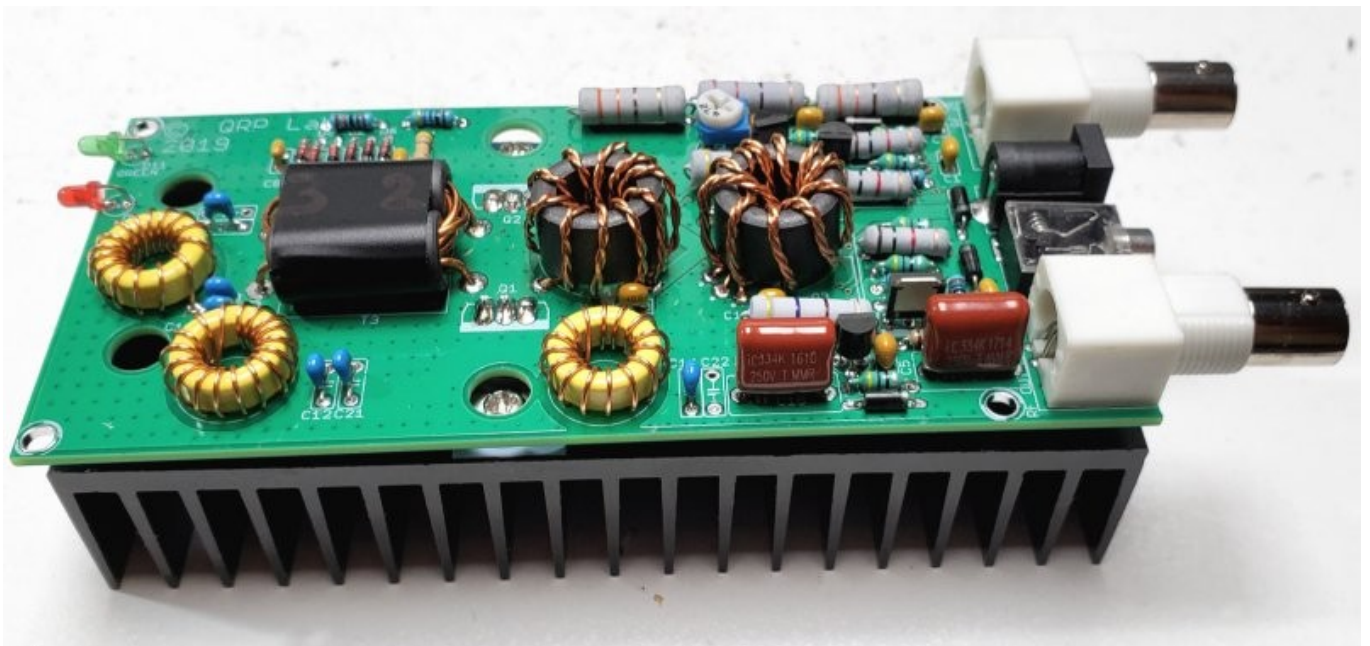

Contents

1. INTRODUCTION – PCB Rev 2.....	4
2. GENERAL ASSEMBLY GUIDELINES.....	4
3. ASSEMBLY.....	5
3.1 Parts list.....	6
3.2 Trace diagram and parts layout.....	10
3.3 Wind and install output transformer T3.....	10
3.4 Wind and install Low Pass Filter inductor L6.....	13
3.5 Wind and install Low Pass Filter inductors L4 and L7.....	14
3.6 Wind and install bifilar transformer T2.....	14
3.7 Wind and install trifilar transformer T1.....	17
3.8 Install Low Pass Filter capacitors C14 and C18.....	19
3.9 Install Low Pass Filter capacitors C11 and C12.....	20
3.10 Install Low Pass Filter capacitors C19 and C20.....	21
3.11 Install Low Pass Filter capacitors C9 and C21.....	22
3.12 Install capacitors C1, 2, 3, 6, 7, 13 and 16.....	22
3.13 Install capacitors C4 and C5.....	23
3.14 Install capacitors C8 and C10.....	23
3.15 Install diodes D2, 4, 6, 8, 9 and 10.....	24
3.16 Install diodes D1, 3, 5 and 7.....	24
3.17 Install inductors L1, 2, 3, 5, 8, 9 and 10.....	25
3.18 Install resistors R7, 10, 11, 14 and 17.....	25
3.19 Install resistor R15.....	26
3.20 Install resistor R16.....	26
3.21 Install resistor R8.....	27
3.22 Install transistor Q3.....	27
3.23 Install transistor Q4.....	28
3.24 Install transistors Q5 and 6.....	28
3.25 Install IC1.....	29
3.26 Install resistors R1, R6 and R9.....	29
3.27 Install resistors R12 and R13.....	30
3.28 Install resistor R3.....	30
3.29 Install resistors R2 and 4.....	31
3.30 Install trimmer resistor R5.....	31
3.31 Install capacitors C15 and 17.....	32
3.32 Install connector X4: DC Power in.....	32
3.33 Install connector X2: PTT (key).....	33
3.34 Install connector X1 and 3: RF In and Out.....	33
3.35 Install LEDs D11 and 12.....	34

4 NO ENCLOSURE OPTION: PA Transistor installation.....	35
5 ENCLOSURE OPTION installation.....	37
6 CIRCUIT EXPLANATION.....	42
6.1 Schematic.....	42
6.2 Input attenuator.....	44
6.3 Power Amplifier.....	44
6.4 Thermal considerations.....	50
6.5 Low Pass Filter.....	52
6.6 Transmit / Receive switching.....	53
7 Amplifier set-up and operation.....	64
7.1 PA Precautions.....	64
7.2 Power supply.....	65
7.3 Connection to QCX.....	65
7.4 Adjustment.....	66
7.5 Supply voltage value and power output.....	66
8 Measurements.....	67
8.1 Power output vs Supply voltage.....	67
8.2 Low Pass Filter characteristics.....	68
8.3 Keying envelope.....	68
9 Version History.....	69

1. INTRODUCTION – PCB Rev 2

This 50W QCX Power Amplifier has the following features:

- Up to 50W power output with 20V supply, falling to around 25W at 13.8V supply
- Standard 50-ohm input and output
- Fast clean solid-state Tx/Rx switching provides full break-in operation (QSK)
- Can be built for one of 80, 40, 30m or 20m bands with the supplied components (or other bands with suitable choice of Low Pass Filter components)
- Uses two low-cost IRF510 transistors as the power amplifier in push-pull configuration
- Recommended amplifier operation in Class C
- On-board 7-element Low Pass Filter for harmonic attenuation
- Two black anodized heatsinks sized 130 x 28mm with 25mm fins typically limit the temperature rise to < 20C over ambient in normal CW operation
- Through-hole plated PCB, all through-hole components (no Surface Mount Devices)
- All connectors board-mounted: two BNC, one 2.1mm barrel power connector, one 3.5mm jack connector for keying
- PCB size 130mm x 59.5mm (2.744 x 1.338 inches)
- Standard inexpensive components throughout (easy to replace)
- Optional black anodized aluminium enclosure

We hope you enjoy building and operating this kit! Please read this assembly manual carefully, and follow the instructions step by step in the recommended order.

Note that this amplifier is NOT designed for Linear operation; linear operation would require a higher bias current setting on the PA transistors and would result in higher heat dissipation; it may be worthwhile experimenting with this but you will be in experimental territory.

This amplifier is intended for single-band operation and may be built for 80, 40, 30 or 20m using the supplied components. The band-specifying section of the circuit is the Low Pass Filter (LPF). You may build it for other bands by suitable choice of low pass filter components; the LPF component values should be the same as in the QCX kit <http://qrp-labs.com/qcx>, or the QRP Labs LPF kit <http://qrp-labs.com/lpfkit>. T50 sized toroids must be used, and NP0/C0G type capacitors with at least 100V rating, sufficient to handle the 50W output power.

A suitable power supply is required, for full power 50W operation it will need to be capable of providing at 20V at a current of around 5A.

2. GENERAL ASSEMBLY GUIDELINES

Assembly of this kit is quite straightforward. But there are quite a lot of components. So please keep them methodically in trays or some convenient storage boxes. Be careful not to misplace any. The usual kit-building recommendations apply: work in a well-lit area, with peace and quiet to concentrate. **Some of the semiconductors in the kit are sensitive to static discharge.**

Therefore, observe Electrostatic discharge (ESD) precautions.

And **FOLLOW THE INSTRUCTIONS!!** Don't try to be a hero and do it without instructions!

A jeweler's loupe is really useful for inspecting small components and soldered joints. You'll need a fine-tipped soldering iron too. It is good to get into the habit of inspecting every joint with the magnifying glass or jeweler's loupe (like this one I use), right after soldering. This way



you can easily identify any dry joints or solder bridges before they become a problem later on when you are trying to test the project.

Triple check every component value and location BEFORE soldering the component! It is easy to put component leads into the wrong holes, so check, check and check again! It is difficult to de-solder and replace components, so it is much better to get them correctly installed the first time. In the event of a mistake, it is always best to detect and correct any errors as early as possible (immediately after soldering the incorrect component). Again, a reminder: removing a component and re-installing it later is often very difficult!

Please refer to the layout diagrams and PCB tracks diagrams and follow the steps carefully.

The component colour coding of the layout diagram at every step of the assembly instructions is as follows (kind of: components past, present and future):

- Components shaded grey have already been installed
- Components shaded red are the ones being installed in the current assembly step
- Components shaded white are the ones which have not yet been installed

VERY IMPORTANT SOLDERING ADVICE: when soldering a component pin that goes to ground, you need to allow extra time with the soldering iron. Ground pads are separated from the ground-plane by what are called “thermals”, a gap between the pad and the ground-plane which is bridged in 4 places at 0, 90, 180 and 270-degree around the circle. This is standard practice. However, you may STILL find that it is harder to solder ground connections, because the soldering iron heat is dissipated away more quickly. If a component ground connection is broken it can sometimes have catastrophic consequences. So please check and recheck, particularly with ground connections.

The following tools are required: good soldering iron, preferably 50-60W; wire-cutters; screw-drivers; electrical insulation tape; Digital Volt Meter (DVM) or similar for continuity testing; marker pen.

3. ASSEMBLY

Deburr the ferrite rings and tubes by gently but firmly scraping them with a pair of wire-cutters or similar as shown. This should smooth any sharp edges and reduce the risk of cutting the insulation of the enameled wire.



Refer to the parts list and accompanying photographs, carefully inventory the components and familiarize yourself with the kit contents.

3.1 Parts list

This parts list shows the through-hole components to be inventoried and installed in the assembly.

Resistors

R1, 6, 9	1K 1W, brown-black-red-gold OR brown-black-black-brown-brown (3pcs)
R2, 4	330-ohm, 2W, orange-orange-brown-gold OR orange-orange-black-black-brown (2pcs)
R3	22-ohm, 2W, red-red-black-gold OR red-red-black-gold-brown
R5	4.7K trimmer potentiometer
R7, 10, 11, 14, 17	10K, ¼W, brown-black-black-red-brown (5pcs)
R8	470K, ¼W, yellow-purple-yellow-gold OR yellow-purple-black-orange-brown
R12, 13	470-ohm, 2W, yellow-purple-brown-gold OR yellow-purple-black-black-brown (2pcs)
R15	1.5K, ¼W, brown-green-red-gold or brown-green-black-brown-brown
R16	470-ohm, ¼W, yellow-purple-black-black-brown

Capacitors

C1, 2, 3, 6, 7, 13, 16	1uF, 50V, code "105" (7pcs)
C4, 5	22nF, 50V, code "223" (2pcs)
C8, 10	47pF, 250V, code "470" (2pcs)
C9, 11, 12, 14, 18, 19, 20, 21	Band-dependent capacitors, see text
C15, 17	0.33uF, 250V, code "334" (2pcs) 180pF, 250V, code "181" (2pcs) – not used in 40m kit 270pF, 250V, code "271" (2pcs) – not used in 20m kit 390pF, 250V, code "391" (2pcs) – not used in 40m kit 680pF, 250V, code "681" (2pcs) – not used in 20m kit

Semiconductors

D1, 3, 5, 7	1N4007 (4pcs)
D2, 4, 6, 8, 9, 10	1N4148 (6pcs)
D11	3mm green LED
D12	3mm red LED
Q1, 2	IRF510, TO220, MOSFET (2pcs)
Q3	FQPF2N60C, TO220, MOSFET
IRFU9024	IRF9530, MOSFET
Q5, 6	BS170, TO92, MOSFET (2pcs)
IC1	78L05, 5V voltage regulator

Inductors

L1, 2, 3, 5, 8, 9, 10	47uH molded inductor, yellow-purple-black-silver (7pcs)
L4, 6, 7	T50-6 toroid, yellow, (3pcs)
T1, 2	Ferrite toroid, black (2pcs)
T3	Made from 2pcs ferrite tube (black)

Miscellaneous

PCB	130 x 59.5mm PCB, double-sided through-hole-plated FR4
1mm diameter wire	Enameled wire (40cm)

0.6mm diameter wire
X1, 3
X2
X4
Pad
Insulating washer
9mm M3 screw
6mm M3 screw
Heatsink

Enameled wire (320cm)
BNC Connector (2pcs)
3.5mm stereo jack socket
2.1mm DC barrel power connector
TO220 insulating silicone pad (2pcs)
2pcs white plastic insulating washer
Pan-head screw (2pcs)
Pan-head screw (4pcs)
130mm x 28mm x 25mm deep (2pcs)

Enclosure kit (OPTIONAL)

Enclosure
Screw
Feet

63w x 25h x 130d mm enclosure, drilled, cut and engraved
Enclosure front and rear panel mounting screws (8pcs)
Self-adhesive rubber cabinet feet (4pcs)

The main 50W Amplifier kit bag contains the PCB, two smaller bags of components, and one small plastic box. The plastic box contains the powdered iron toroidal and ferrite cores, in order to prevent breakage during shipping.

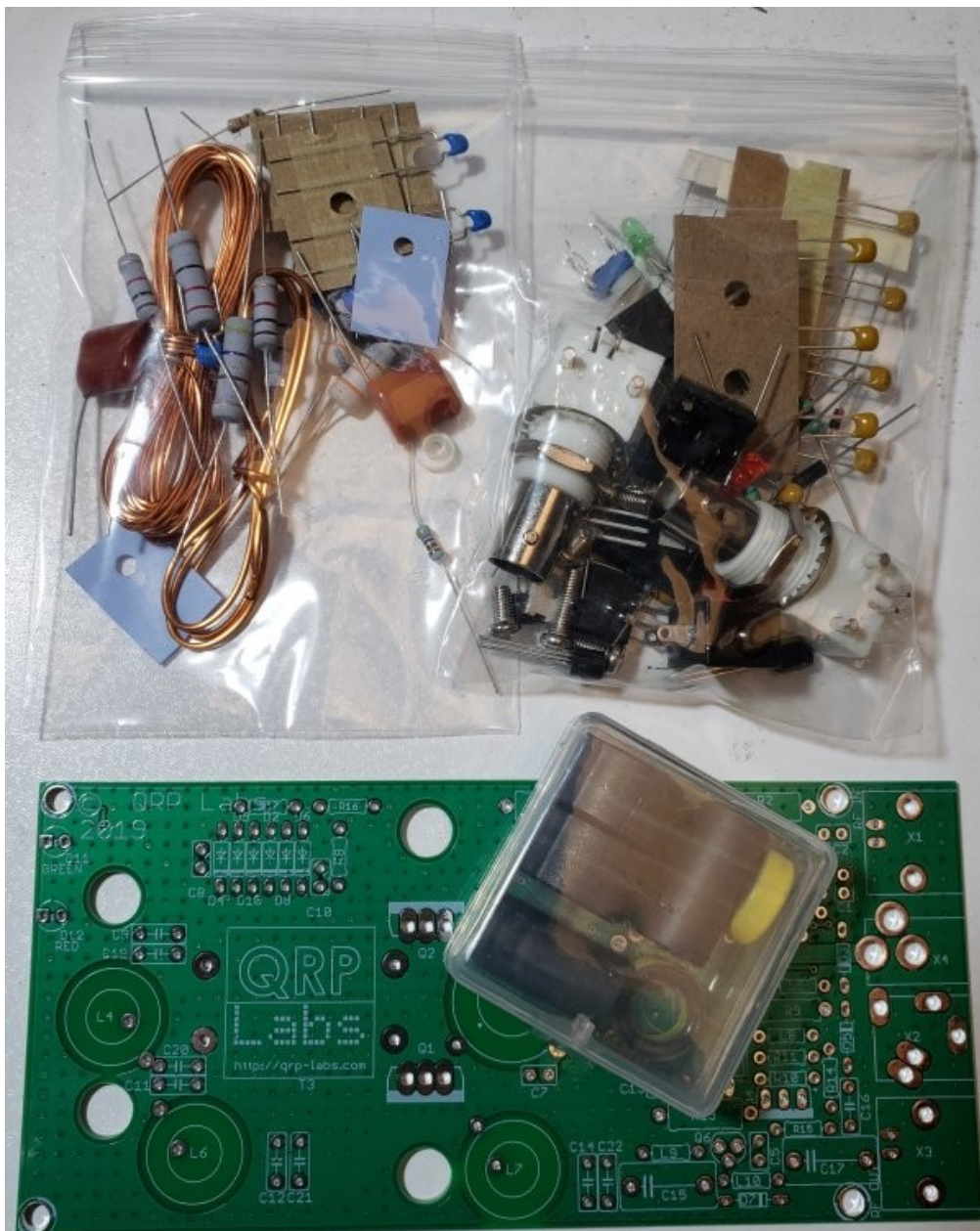

0.6mm wire



1mm wire



0.33uF 250V capacitors



470-ohm resistors



330-ohm resistors



22-ohm resistor



1K resistors



470K resistor



1.5K resistor



470-ohm resistor



Silicone insulating pads



Insulating plastic washers



680pF capacitors

390pF capacitors

180pF 270pF 47pF capacitors



Ferrite tubes



Ferrite toroids



T50-6 powdered iron toroids



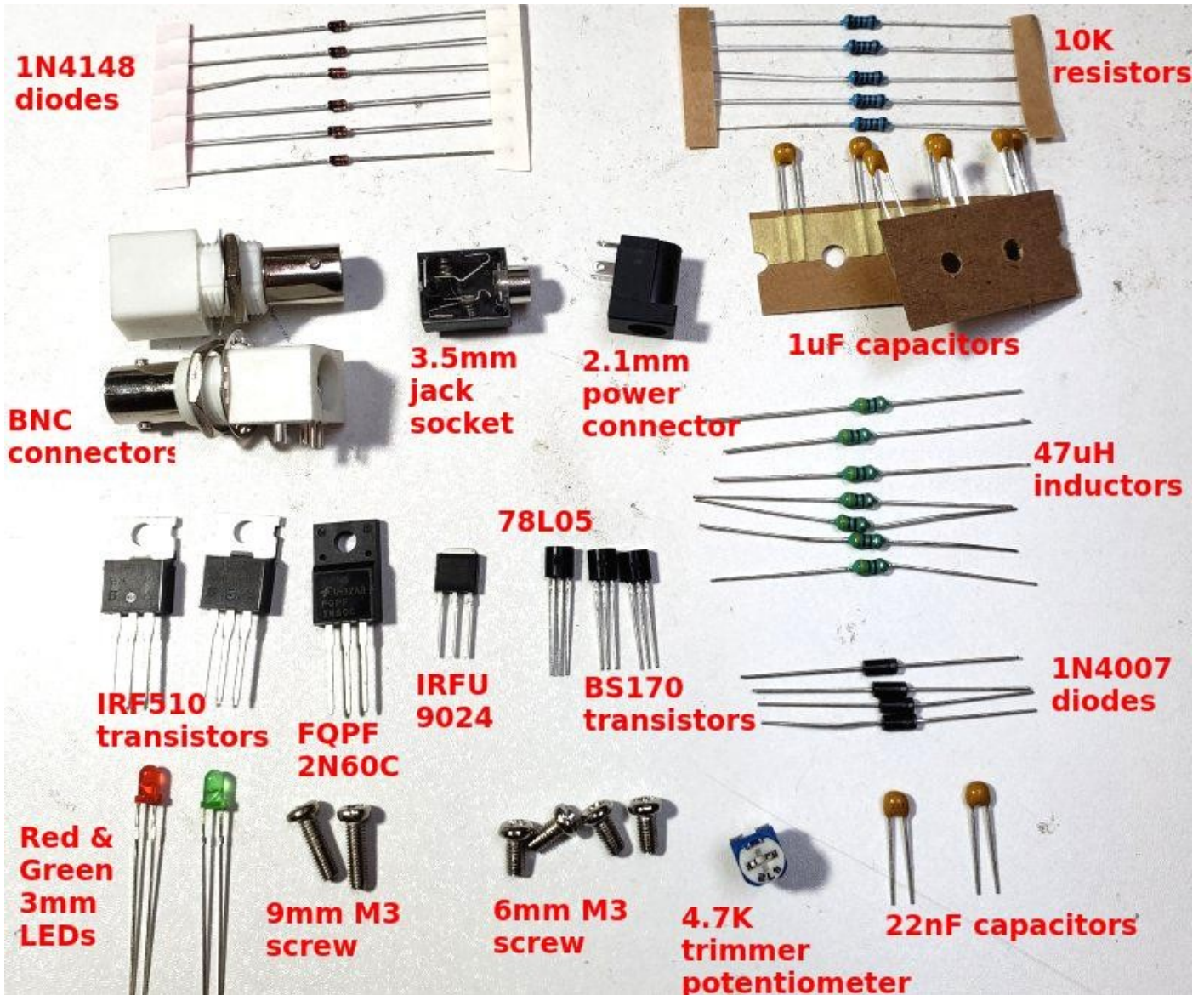

3.2 Trace diagram and parts layout

Red = Top side; Blue = bottom side; Green = pads.

There are only two layers (nothing is hidden in the middle). Not shown in these diagrams are the extensive ground-planes, on both sides of the board. Practically everything on both layers that isn't a RED or BLUE track, is ground-plane! The two ground-planes are connected at frequent intervals (not more than 0.1-inches) by vias.

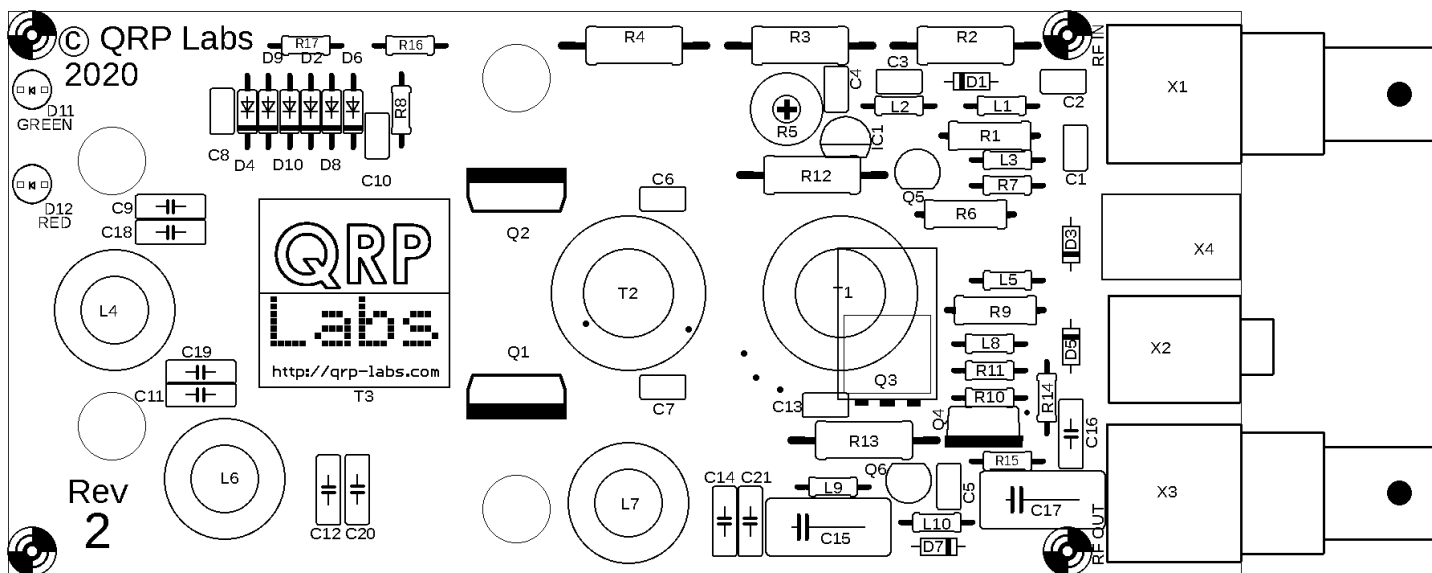
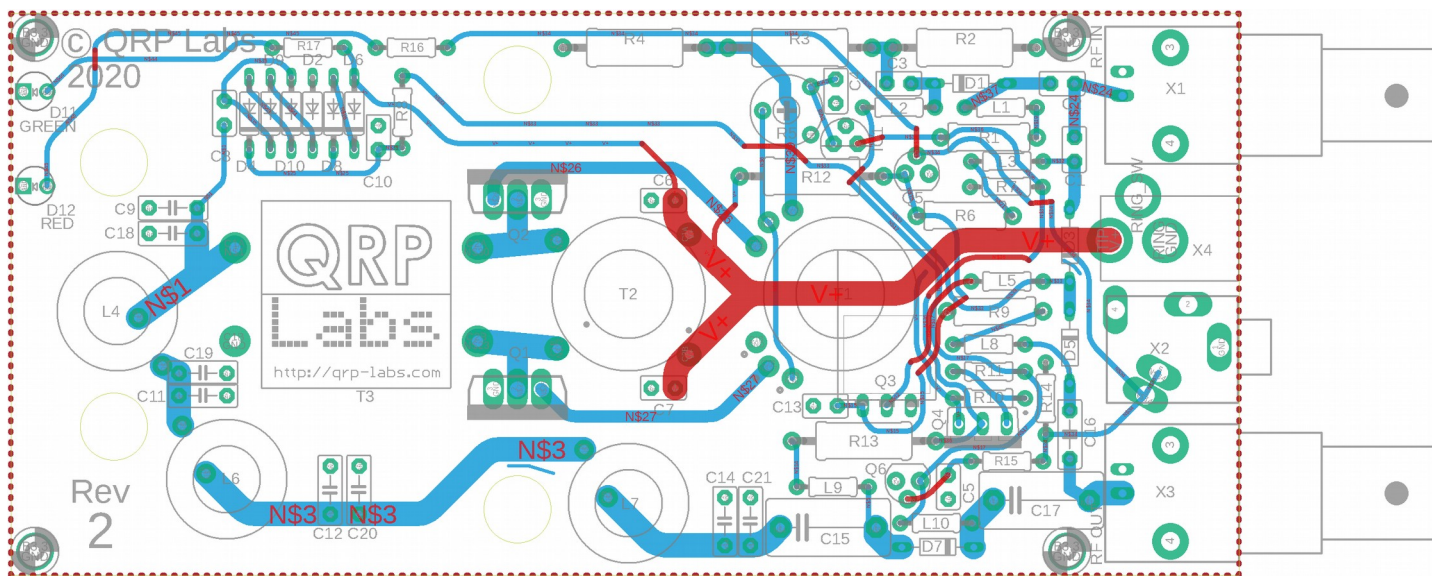

3.3 Wind and install output transformer T3

We start with the installation of the transformers and inductors, which are generally the most difficult components; doing these first means we have space around them so it is easier to access the wires etc.

First is the output transformer, T3. The windings are made from the thick, 1mm diameter enameled copper wire. They are wound on the two ferrite tubes, which are placed side-by-side to make a large binocular core.

I recommend taping the two tubes together using electrical tape; it just helps keep everything nicely held together while winding the turns. An alternative would be to epoxy glue the two tubes together (photo, right).

The turns ratio of the transformer (and the actual number of turns) is 2:3. Note that "1 turn" means the wire passes through the central hole of BOTH tubes.

It is essential to have some way of identifying the windings. If you install the kit with the transformer in backwards, the power output will be much lower than expected. Unfortunately it is very easy to mix up the transformer, and it is very difficult to tell which is the 2-turn winding and which is the 3-turn winding, after the windings have been completed.

For this reason it is strongly recommended to mark the two sides of the transformer in some way. In the photo (right), this has been done this simply with a ball-point pen. Write 3 on the left side (the secondary winding, having 3 turns) and 2 on the right side (the primary winding, having 2 turns). If you write on the middle part of the tape then it is less likely that the ink will be worn off during handling of the transformer during the installation on the PCB.



Wind the 2-turn primary first (below left). The turns start and end on the RIGHT side of the core, as shown. **Take care not to scrape the enamel off the wire!**

Wind the 3-turn secondary (below right). The turns start and end on the LEFT side of the core, as shown. **Take care not to scrape the enamel off the wire!**

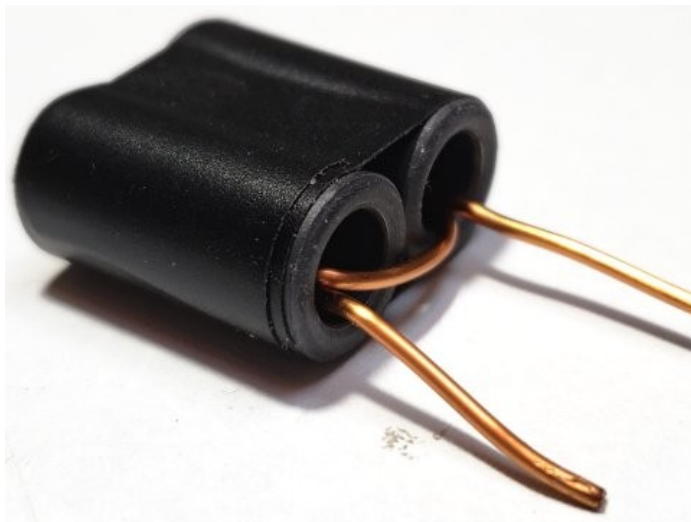

The enamel on the wire is a type which burns off easily with heat from the soldering iron. Nevertheless the wire is 1mm thick and will quickly conduct heat away; the result is that it can be difficult to heat up the wire to a sufficient temperature that the enamel insulation burns off.

The solution to this is to gently scrape the ends of the wires, such that the enamel is removed. Then the wire can be easily tinned with solder. Hold the wire end in a large blob of solder for about 10 seconds to ensure remaining enamel is burned away. Ensure not much solder is left on the wire after tinning, otherwise it will be hard to fit the wire into the holes on the PCB.

Cut the wires so that the binocular core body stands elevated 5mm from the workbench (below left). Then scrape the enamel from 5mm of the wire ends, and tin (below right).



Install the transformer in the PCB as shown in red (below). Be VERY sure that the 2-turn primary winding wire ends are on the right side, nearest to the transistors Q1 and Q2; whereas the 3-turn secondary winding wire ends must be on the left, near inductor L4.

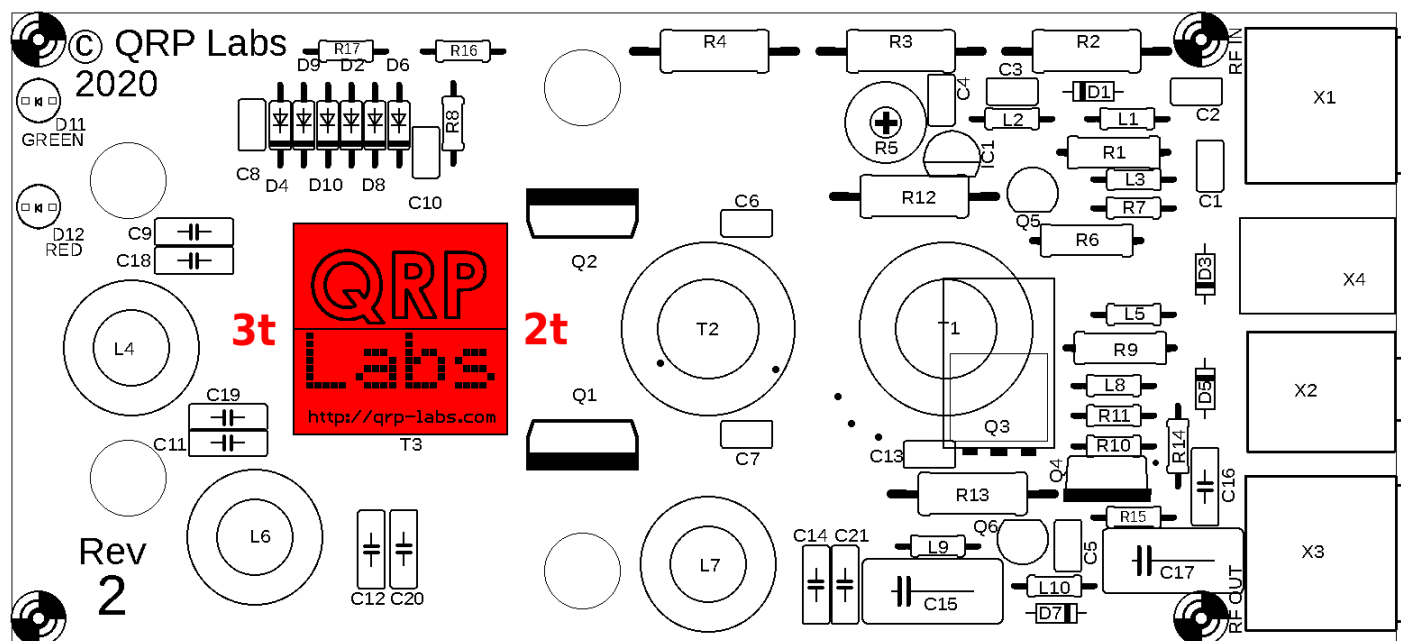

Now use a DVM, set to resistance mode (or continuity beeper if it has that facility) and hold the black and red probes on the holes shown in the diagram below labeled "DVM" in blue. You should measure continuity (zero resistance). If not, check that the wires are properly tinned and soldered.

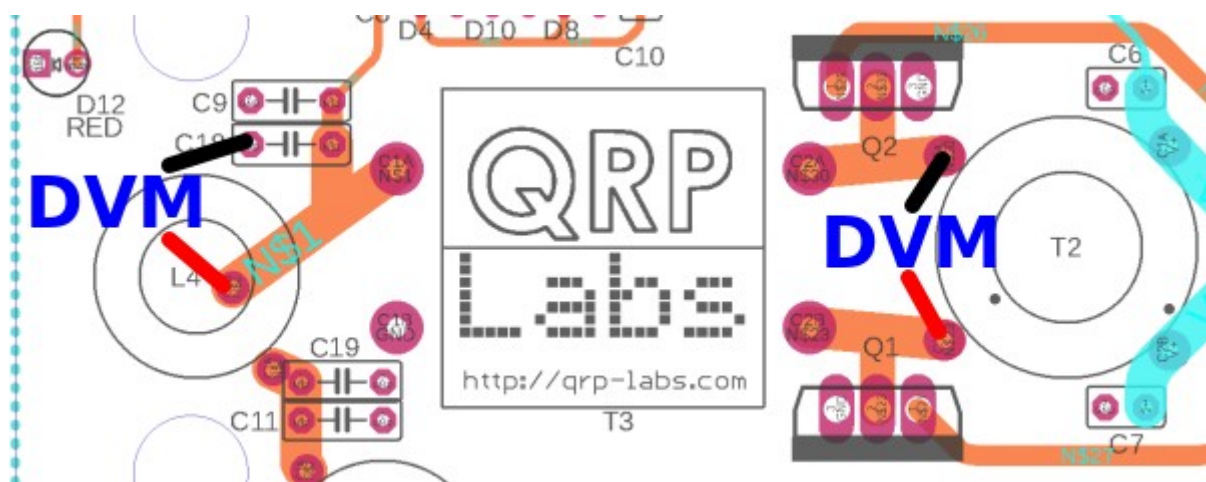

3.4 Wind and install Low Pass Filter inductor L6

Measure and cut 34cm of the 0.6mm wire for winding inductor L6 which is wound on a T50-6 toroid (yellow). The number of turns and inductance of L6 is given in the table below:

Band	Turns	Inductance
80m	27	3.01uH
40m	20	1.70uH
30m	17	1.26uH
20m	14	0.904uH

Start the winding as shown (1). Remember that each time the wire passes through the hole of the toroid counts as "1 turn". Wind the wire as tightly as possible on the core. Wind the turns bunched up next to each other (2). When the number of turns is correct, spread them out evenly around the whole core (3). This method slightly tightens up the windings a bit more, as they are spread out.



Position the wires perpendicular to the toroid and cut the wires at a length of 5mm (4).

Scrape the last 5mm of the wires using a knife or wire cutter and tin them (5). Install and solder (below).

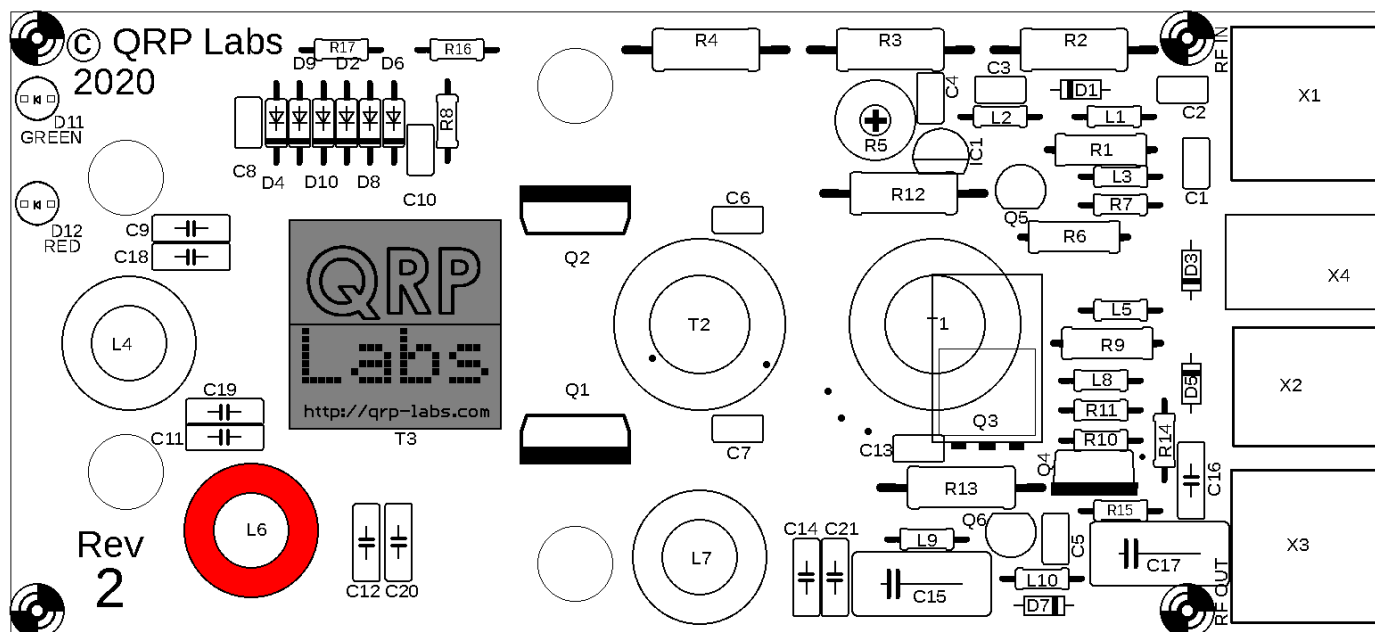

3.5 Wind and install Low Pass Filter inductors L4 and L7

Measure and cut two 30cm lengths of the 0.6mm wire for winding inductors L4 and L7. These two inductors are wound on T50-6 toroids (yellow). The number of turns and inductance of L4 and L7 are given in the table below:

Band	Turns	Inductance
80m	24	2.42uH
40m	17	1.38uH
30m	15	1.09uH
20m	13	0.773uH

Wind and prepare the inductors as in the previous section.

Install L4 and L7 as shown below.

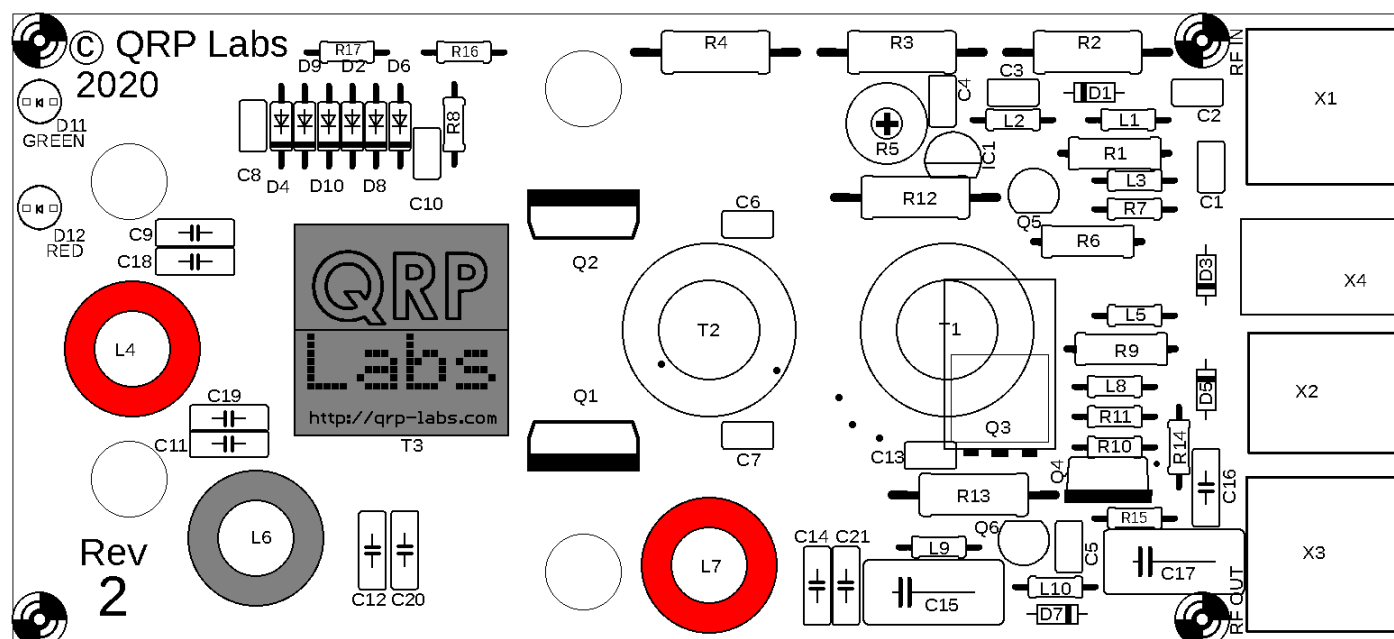

Now use a DVM in resistance or continuity-beeper mode (if available) to check for DC continuity. Resistance should read zero if the DVM is in resistance mode. Poke the red and black probes in the pads of C14 for this measurement. If you do NOT see DC continuity then it means that one or more of the inductor wire ends is not properly stripped of enamel and trimmed; this is a common error.

3.6 Wind and install bifilar transformer T2

Measure the remaining length of 0.6mm wire and cut it into five equal lengths. For example, if the remaining length is 230cm then cut it carefully into five equal lengths of 46cm each.

Two of these wires now need to be prepared as bifilar windings. To do this, hold two ends and twist the wire repeatedly along its entire length. Try to avoid the situation where one wire remains straight, and the other wire just wraps around it. Try to keep the twists even. It is difficult to do this and end up with a beautiful result. Don't worry! Regardless of how imperfect or messy it looks, it is going to work just fine.

The bifilar wire should end up looking something like this (top scale in inches, bottom scale in cm):



Wind 10 turns around one of the ferrite toroids (remember, each time the wire passes through the center counts as one turn). Leave 4-5cm of wire at each end.

Try to wind the wire tightly on the toroid but be careful not to scratch the enamel which could cause short circuits between the wires.

In the end it should end up looking something like this (right).



Now comes the tricky business of determining which wire goes in which hole on the PCB. It has to be done **CORRECTLY** or the kit will not work. **Step by step, slowly and carefully, will ensure success.**

Scrape and tin the wire ends, just for the purposes of identification of windings using a DVM. Use the DVM to identify continuity between a pair of wires. This is one of the windings. Use a felt-tip pen to mark these two wires that have continuity between them. Check again, to make sure you haven't mixed up the wires!



Orientate the wires so that the wires with the black mark are at diagonals. These three photos all show the same thing from different angles and hopefully make it clear.

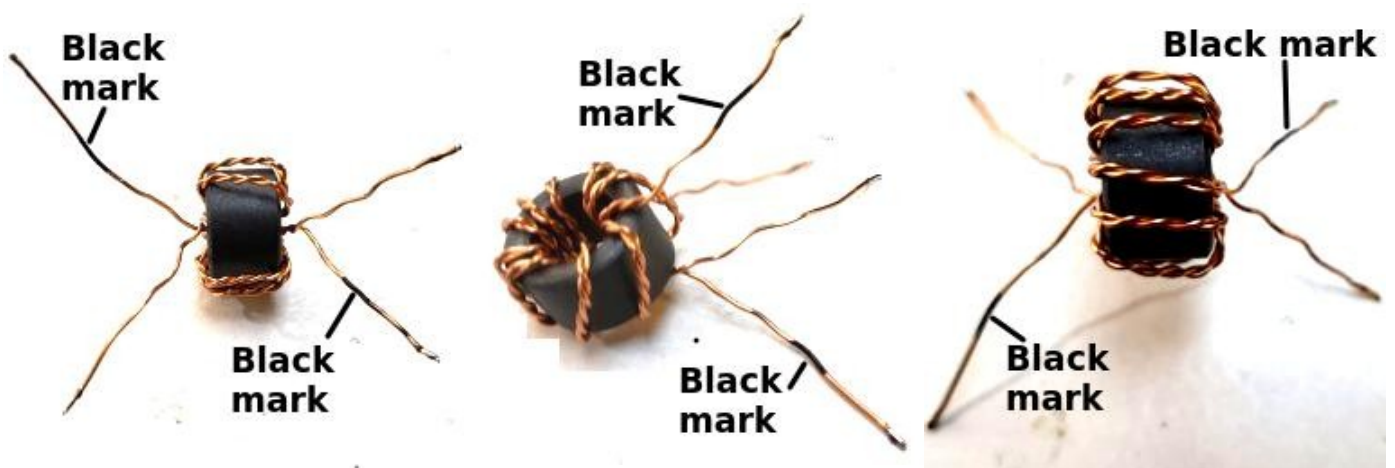

The diagram and explanation below illustrates the correct wire placement. It is **CRITICALLY IMPORTANT** to get this right!

Now lay the toroid down flat on the table as shown and identify the wires which come from the center of the core, over the top of the outside of the core; and those which come out from the underside of the toroid (see right).

All four wires go into holes that are on the circumference of the outer circle of the white silk-screen printing on the PCB.

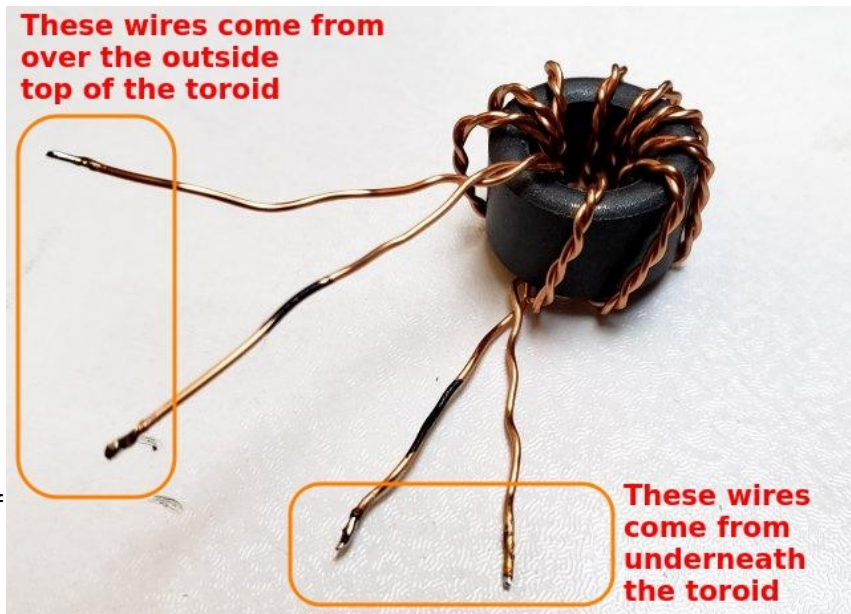

One black wire, that comes over the outside of the top of toroid, must be inserted in the hole nearest the “Q2” text on the PCB (the top left hole). The non-black wire that comes over the top of the outside of the toroid, which is twisted together with this black wire, must be inserted in the hole nearest C6 (the top right hole).

One non-black wire coming from the underside of the toroid goes in the hole near the “Q1” text. The corresponding black-marked wire goes in the hole near C7.

In this way, the lower pair of wires (Q1, C7) are from the twisted pair that comes from UNDER the toroid; the top pair of wires (Q2, C6) are from the twisted pair that comes from the TOP side of the toroid.

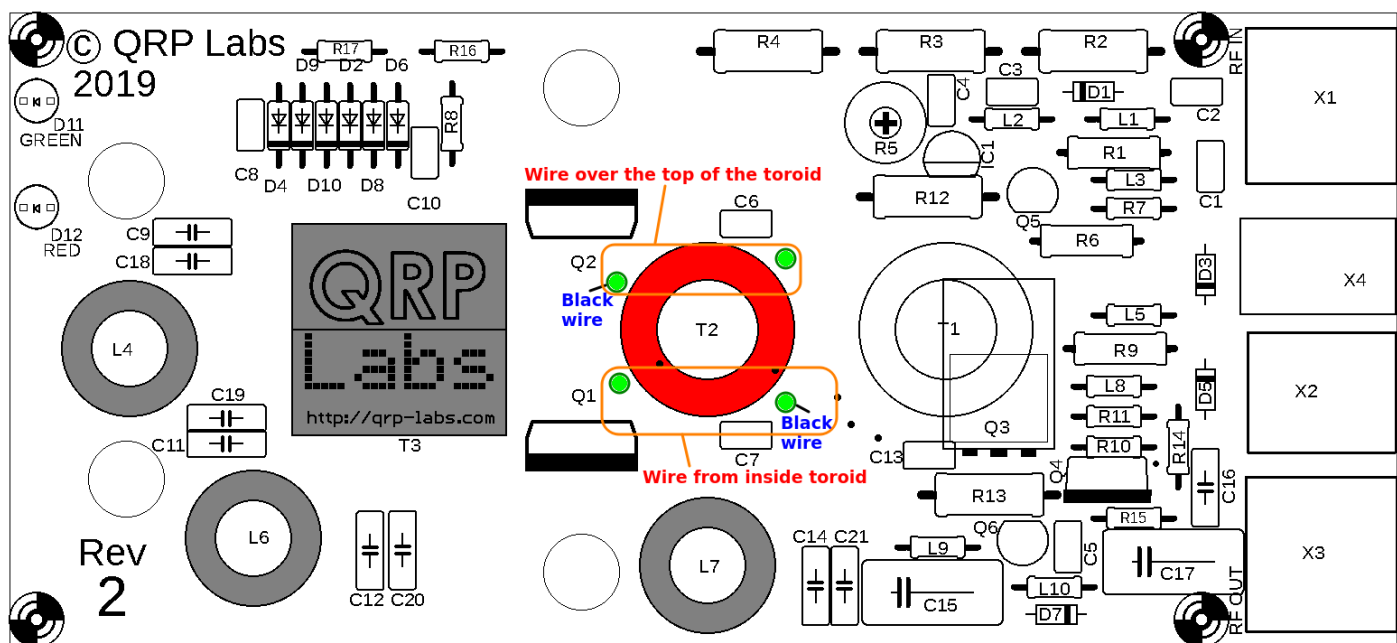

Pull the wires through the holes so that the toroid sits flat on the PCB, and is orientated accurately with the white ink circle drawn on the PCB silkscreen. The toroid won't sit perfectly flat of course, because of the twisted bifilar windings. This is not a problem.

Squeeze the toroid gently to the PCB in the correct position, and cut the black-marked wire nearest Q2, leaving a few spare mm. Now scrape some enamel from the last 5mm of this wire with a knife or wire cutter; it does not have to be perfectly scraped but removing some enamel in this way helps the remaining enamel to burn off easily. Tin it and solder it while it is in place in the hole

on the PCB. Hold the iron on the joint for at least 10 seconds and then feed in some more fresh solder. This should ensure a good joint and all the enamel burned away.

Now similarly cut, prepare and solder the other “black marked” wire, which is the one in the hole nearest to C7. Hold the toroid flat against the PCB in the correct position, while cutting the wire with a few mm protruding; then scrape the wire and tin it and solder it to the pad, while in place; hold the iron for 10+ seconds to ensure a good joint with all enamel burned away.

Use a DVM to measure continuity from the middle of the three pins of transistor Q2’s pads, and the pad at right hand side of capacitor C7. The DVM in resistance mode should measure zero ohms. If it does not, then you have either mixed up the wires or have a poor joint.

Now cut, prepare, and solder the wire in the bottom left hole, nearest to Q1. Check for continuity with the DVM, from the middle pin of transistor Q1, to the right hand side of capacitor C7. You should see continuity here.

Finally, cut, prepare and solder the wire at the top right hole, nearest to C6. Check for good DC continuity with the DVM, from the middle pin of transistor Q1, to the right hand side of capacitor C6.

3.7 Wind and install trifilar transformer T1

The three remaining wires are to be wound into trifilar transformer T1. They should be twisted together in much the same way as the bifilar transformer T2 from the previous section. Again, it is hard to twist three wires neatly and evenly. But again, it is not going to make much difference and the amplifier will work regardless.



Now wind 10 turns carefully around the remaining ferrite toroid (remember one time through the center, counts as 1 turn), again try to keep it compact but be careful not to pull hard, scraping the wires against the toroid which could remove the enamel and cause short circuits later.

In the end you hopefully end up with something looking like this (see right).

Identification of the wires is similar to the earlier bifilar transformer T2. First scrape the last 5mm of the wires, and tin them – so that you can touch the DVM probes there to determine continuity.

Find each pair for which continuity exists and arrange the wires nicely so that the windings are in order.

Label the wires again by drawing black felt tip pen marks.



This photograph (right) illustrates the process. Prefixes T (for Top) and B (for Bottom) are used to indicate whether the wire comes out from the top side or the bottom side of the toroid when it is laying flat on the table.

Wires T-0 and B-0 have continuity.

Wires T-1 and B-1 have continuity and are labeled with a single black marker stripe.

Wires T-2 and B-2 have continuity and are labeled with two black marker stripes.

It is utterly critically important to insert these wires into the correct PCB holes, as labeled in the diagram below. There are two sets of 3-holes. The top set of holes is to be connected to the 3 twisted wires coming over the top of the toroid. The bottom set of three holes is to be connected to the 3 twisted wires coming from under the toroid core.

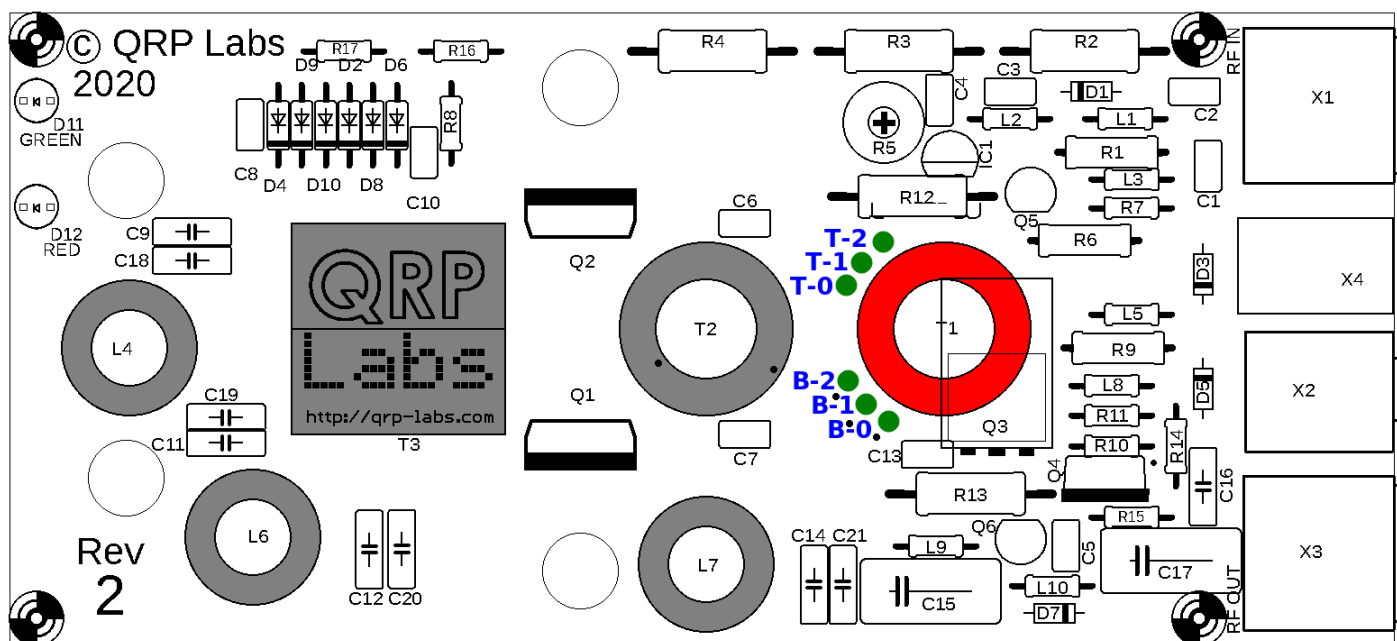
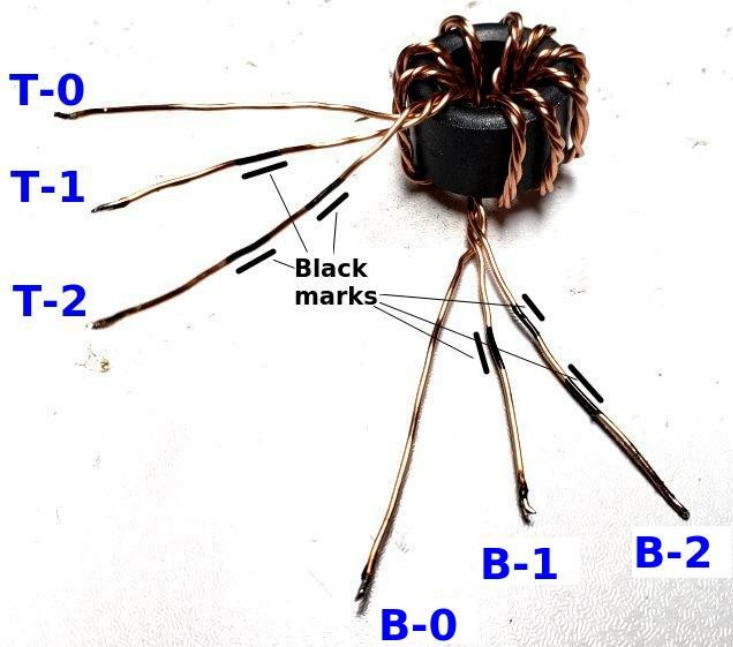

With all this in mind, we can start soldering.

Again, hold the T1 toroid flat against the PCB, orientated as precisely as possible over the white circle drawn on the PCB silkscreen. Put the correct wires in the correct holes. Pull the wires through reasonably tightly, still keeping the toroid in position flat on the PCB. Make sure the labeled wires are in the correct holes, before soldering. It is hard to fix, later!

Now cut wire B-2 on the underside of the PCB, leaving a few mm spare. Scrape the insulation from the last 5mm or so of the wire. Tin and solder it while it is in place in the hole. You will need to hold the soldering iron to the joint for more than 10 seconds, firmly, and add more fresh solder from time to time; the pad is grounded so the ground plane will dissipate heat and make achieving a good joint more difficult.

Similarly cut wire T-2 with a few mm spare, scrape it, tin and solder it while it is in place in the hole, holding the iron in position for 10 seconds to ensure all enamel is burned away and there is a good joint. Now look for resistor R4 at the top of the PCB; hold the DVM probes to the pads of R4

and check for DC continuity (zero resistance). If you do not get zero resistance, then either you have installed the wires in the wrong holes, or you have failed to burn off all the enamel and achieve good joints to the wire. Fix it before proceeding!

Next repeat the cut/tin/solder procedure for wires T-1 and B-1. Check with a DVM for DC continuity between the right-hand pin of transistor Q1's three pads, and the wiper pin of trimmer potentiometer R5. R5 has three pins and the "wiper" pin is the one just to the left of the + symbol on the PCB silkscreen. Again – do not proceed until DC continuity (zero resistance) is seen here.

Finally repeat the same procedure for wires T-0 and B-0. Check for DC continuity between the left pin of Q2's three pads, and the same wiper pin of the trimmer potentiometer R5.

If all is well, this is the most difficult parts of the assembly over, the rest is relatively easy; you should now have an assembly that looks like the photograph below. Note that in the photo the blue low pass filter capacitors have been installed, which yours will not have yet (this was for measurement purposes of the LPF characteristics).

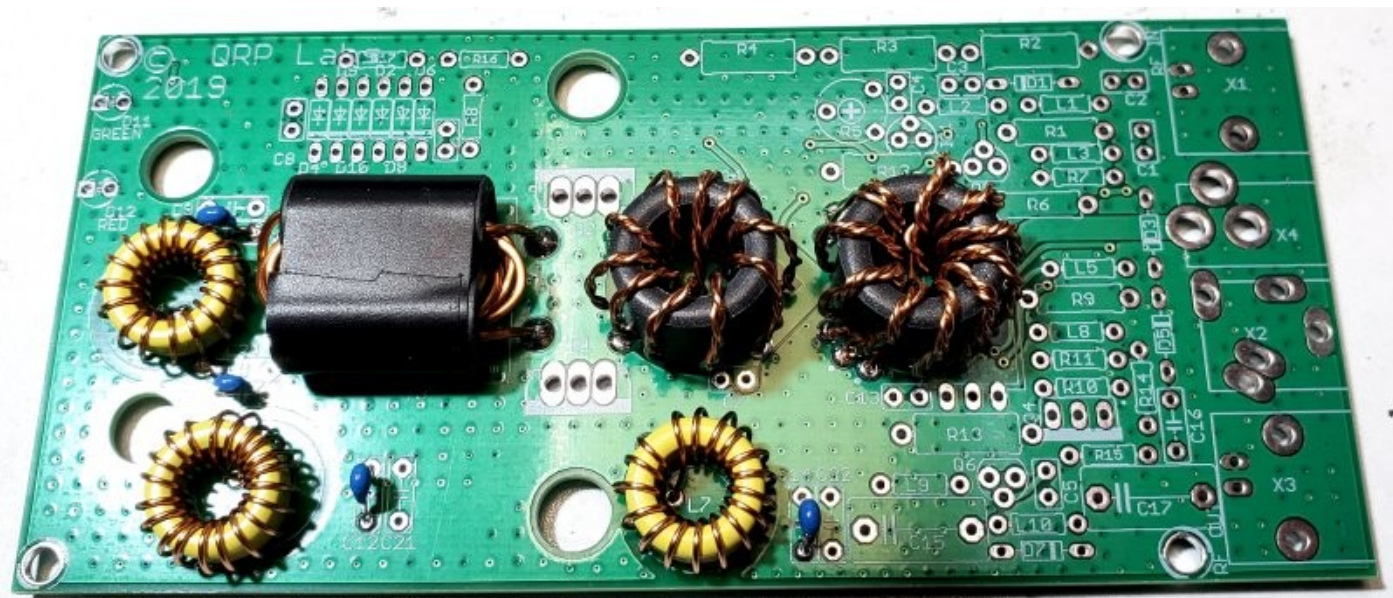

3.8 Install Low Pass Filter capacitors C14 and C18

These two capacitors are 250V NP0/C0G types. The capacitor value depends on the band the 50W PA kit is being built for, as follows:

Band	Value	Code
80m	270pF	"271"
40m	270pF	"271"
30m	270pF	"271"
20m	180pF	"181"

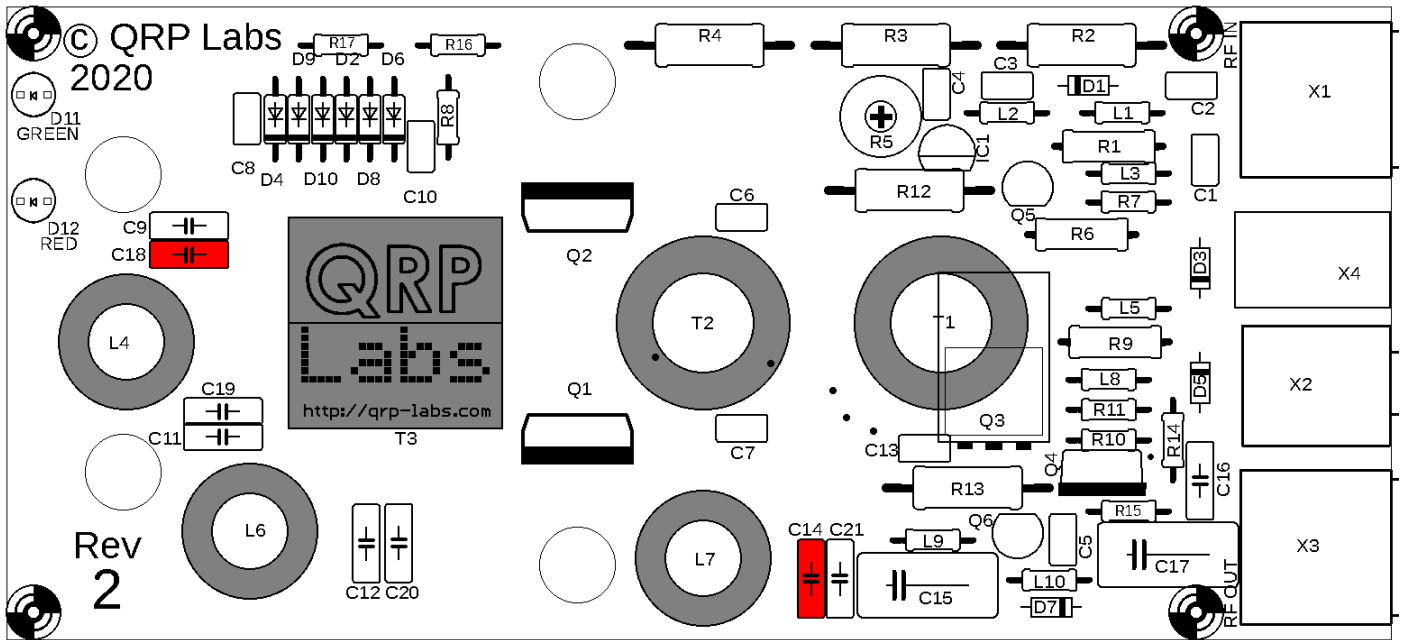

3.9 Install Low Pass Filter capacitors C11 and C12

These two capacitors are 250V NP0/C0G types. The capacitor value depends on the band the 50W PA kit is being built for, as follows:

Band	Value	Code
80m	680pF	"681"
40m	680pF	"681"
30m	390pF	"391"
20m	390pF	"391"

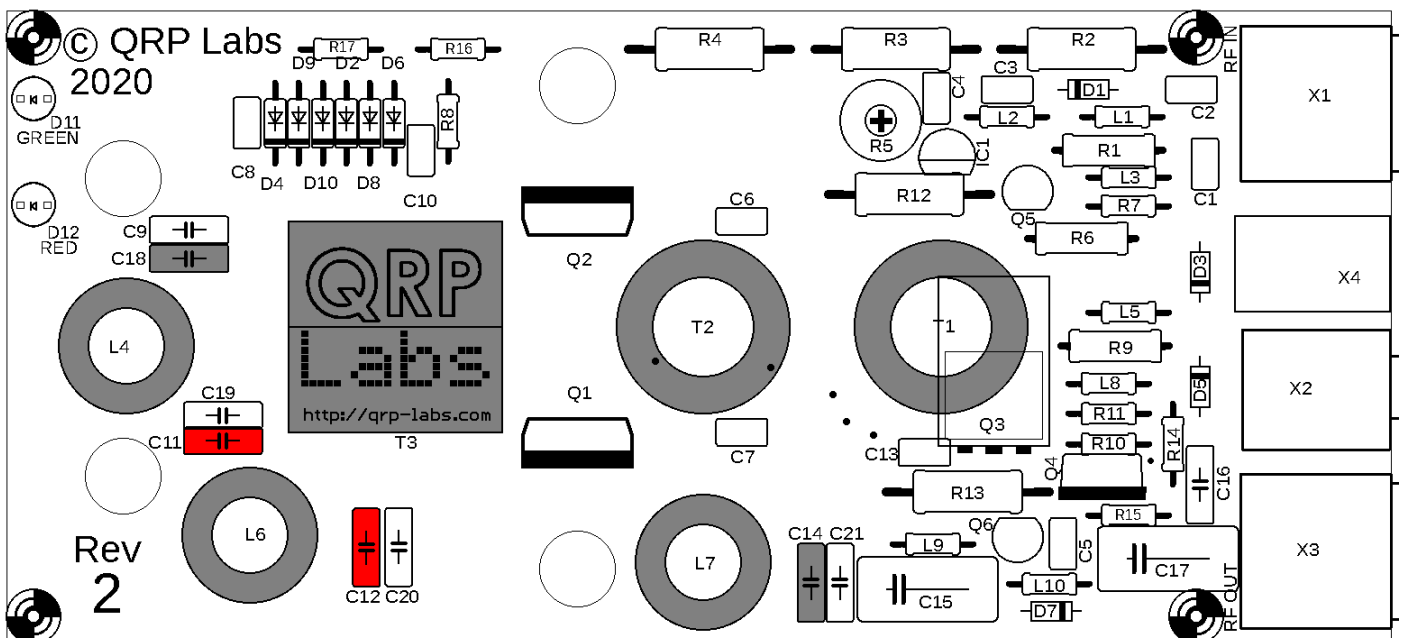

3.10 Install Low Pass Filter capacitors C19 and C20

These two capacitors are 250V NP0/C0G types. The capacitor value depends on the band the 50W PA kit is being built for, as follows:

Band	Value	Code
80m	390pF	"391"
40m	Not installed	
30m	180pF	"181"
20m	Not installed	

The capacitors are **ONLY** installed for the 30m and 80m versions of the kit.

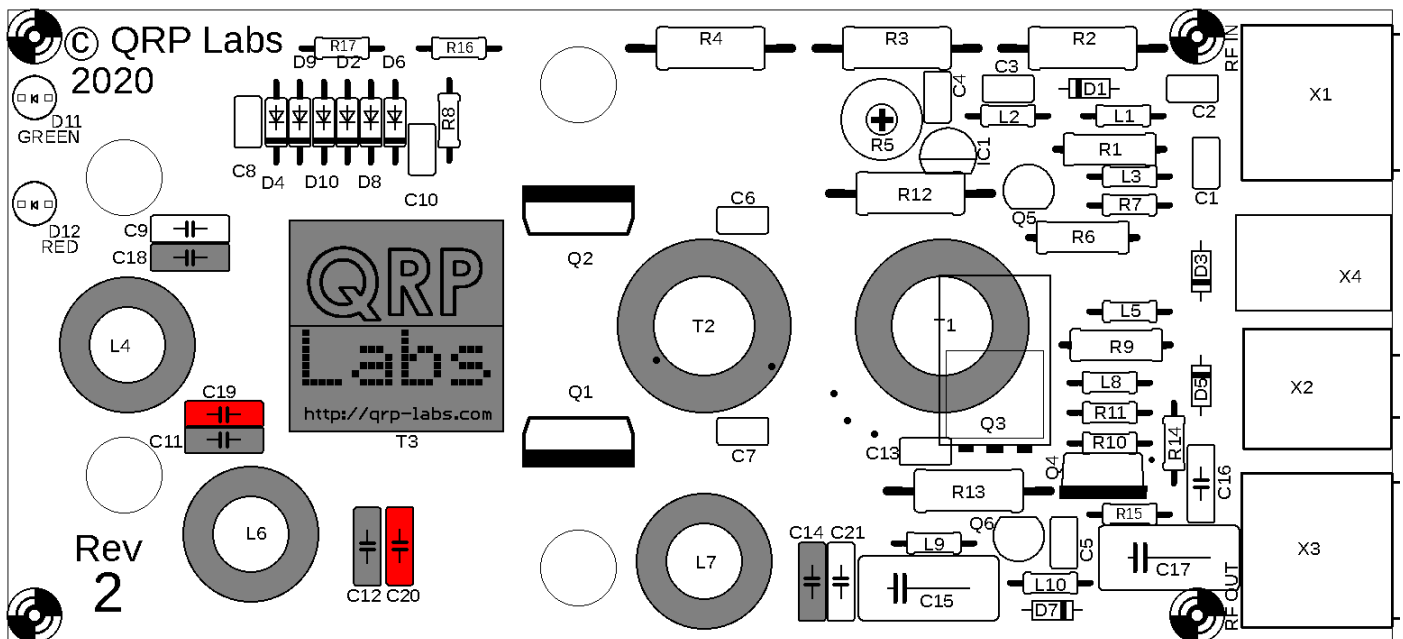

3.11 Install Low Pass Filter capacitors C9 and C21 (80m only)

These two capacitors are 250V NP0/COG types. The value is 180pF (code "181") and the capacitors are **ONLY** installed for the 80m version of the kit.

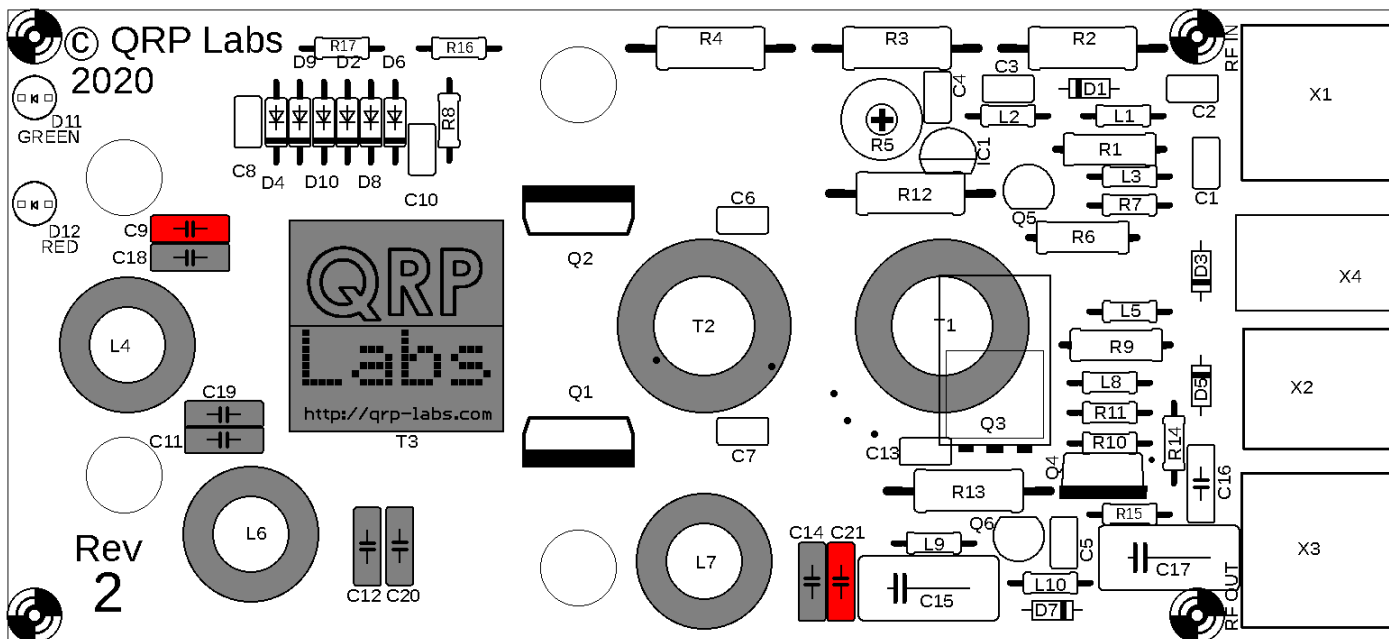

3.12 Install capacitors C1, 2, 3, 6, 7, 13 and 16

These are 1uF 50V ceramic capacitors, code "105".

Note that C6 and C7 are very close to the bifilar transformer T2. As long as you have positioned T2 nicely over the circle printed on the silkscreen, there should be enough space for the capacitors.

Note that C16 holes are spaced 0.2-inches which does not match the capacitor's 0.1-inch wire spacing; this is a minor PCB design error. Just spread the wires of the capacitor to fit in the holes.

Make sure to install capacitors only inside the rectangular boxes indicated on the PCB silkscreen.

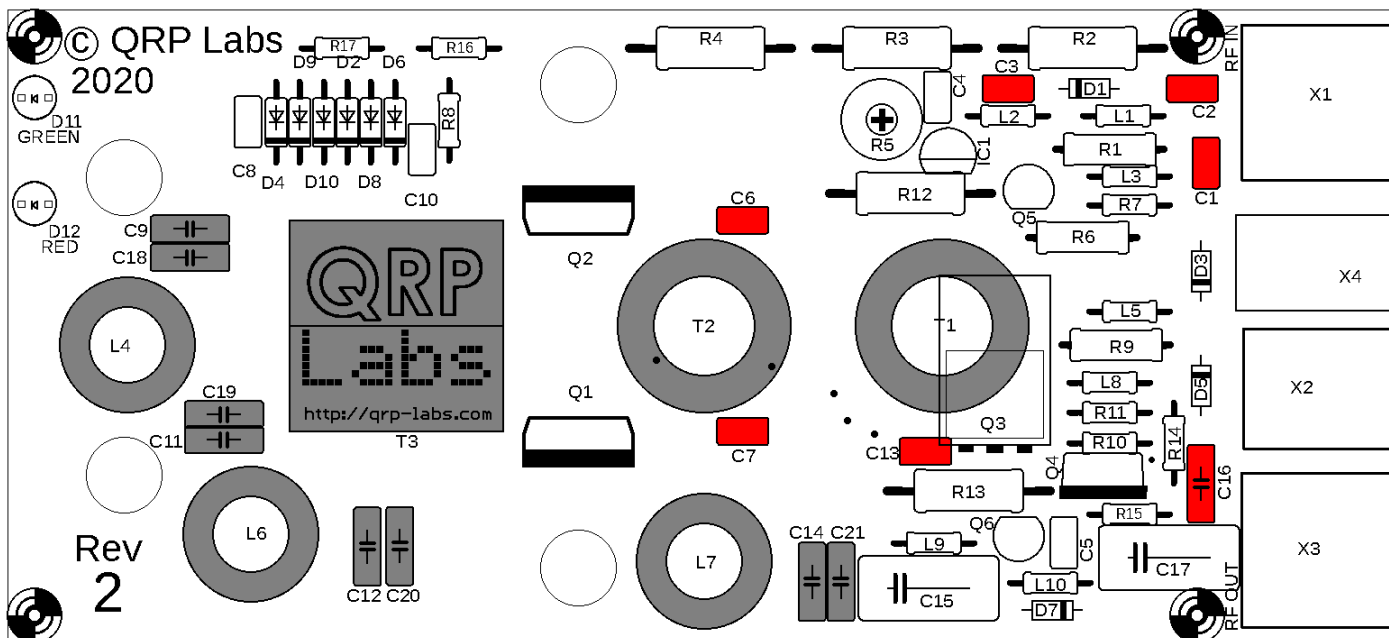

3.13 Install capacitors C4 and C5

These are 22nF (0.022uF) 50V ceramic capacitors, code "223".

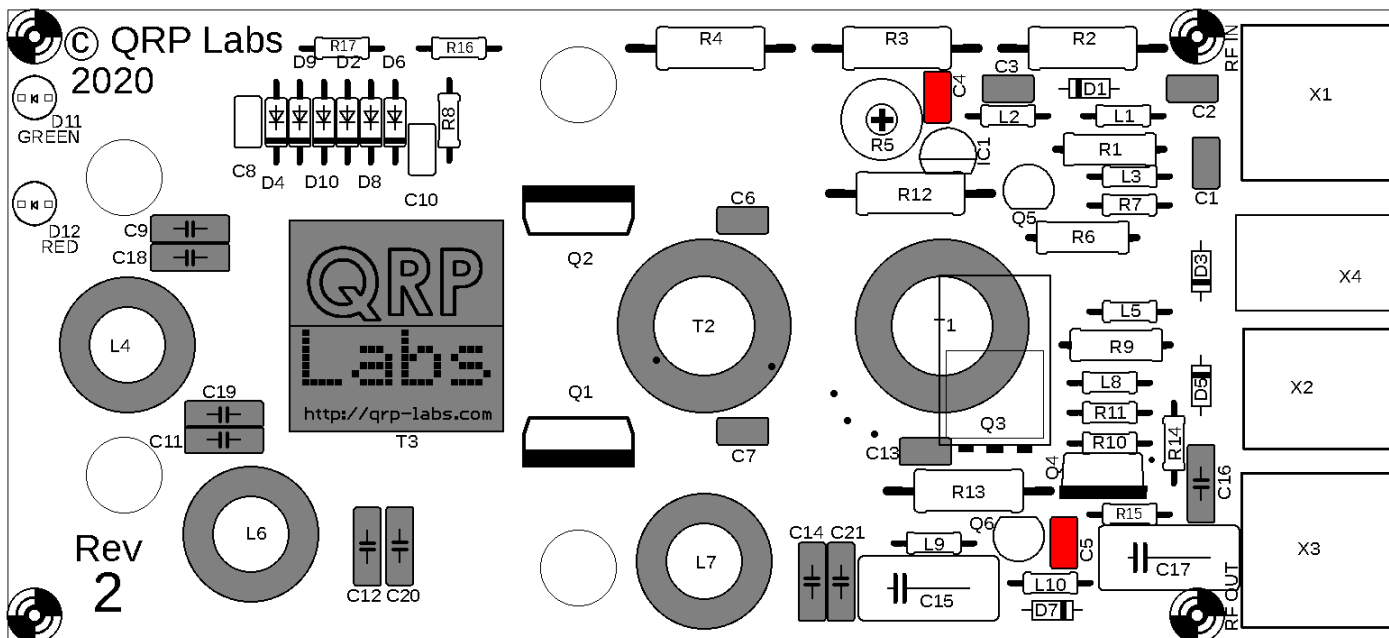

3.14 Install capacitors C8 and C10

These are 250V NP0/C0G types with value 47pF, code "470".

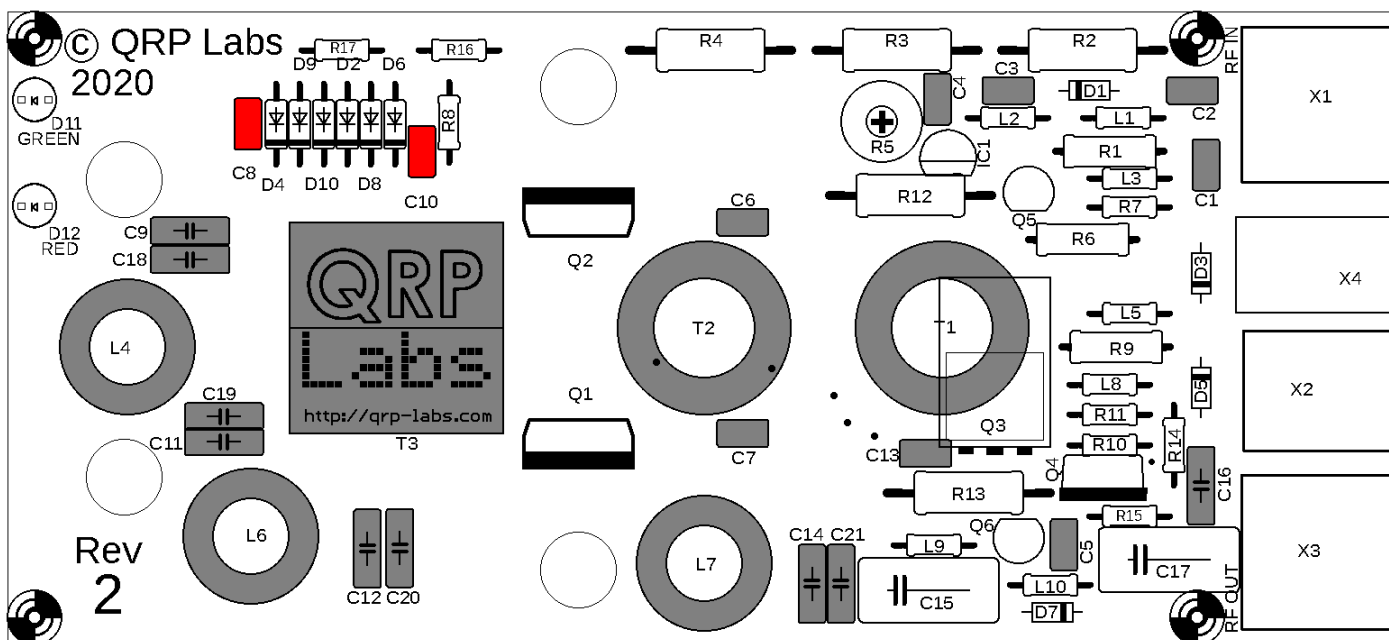

3.15 Install diodes D2, 4, 6, 8, 9 and 10

These are 1N4148 diodes. The orientation is important! Bend the wires as shown. Install all the diodes in a row, with the black stripe on the diode body facing the lower edge of the board, so that the black stripe is aligned with the corresponding white stripe on the silkscreen printing.

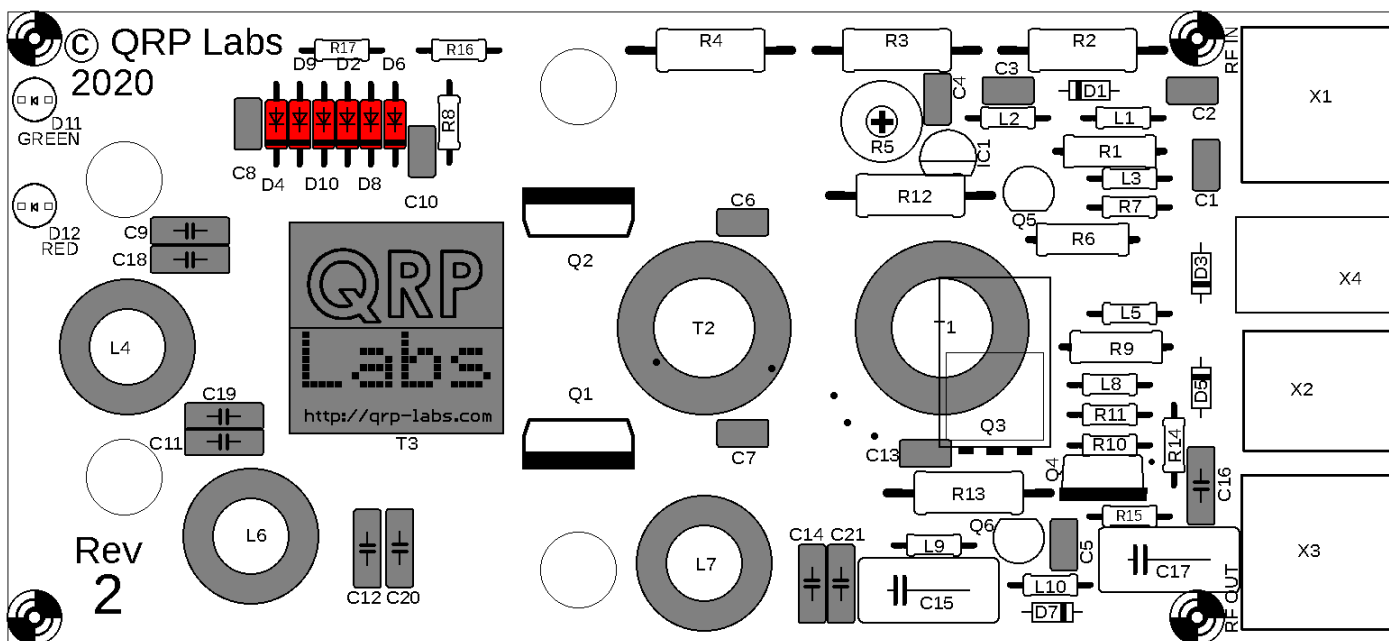

3.16 Install diodes D1, 3, 5 and 7

These are 1N4007 diodes. The orientation is important! Bend the wires as shown. Install the diodes with the white stripe on the diode body aligned with the corresponding white stripe on the silkscreen printing.

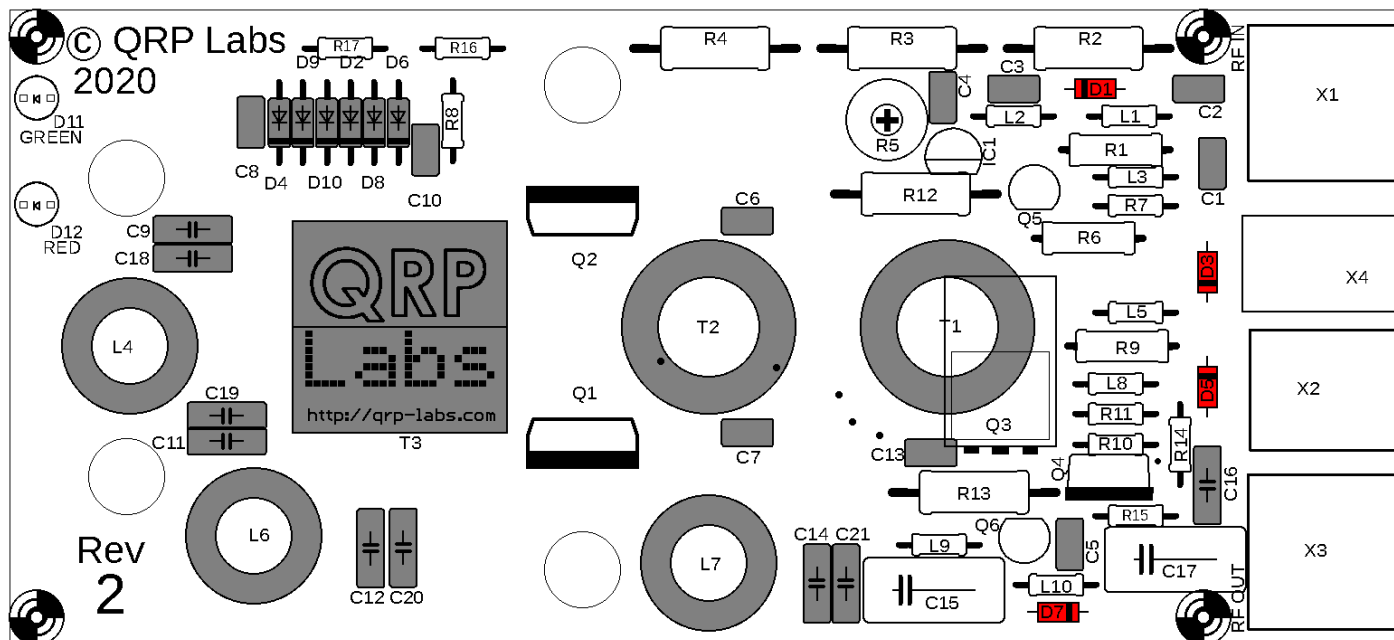

3.17 Install inductors L1, 2, 3, 5, 8, 9 and 10

These are 47uH axial molded inductors. Bend the leads as shown and install carefully.

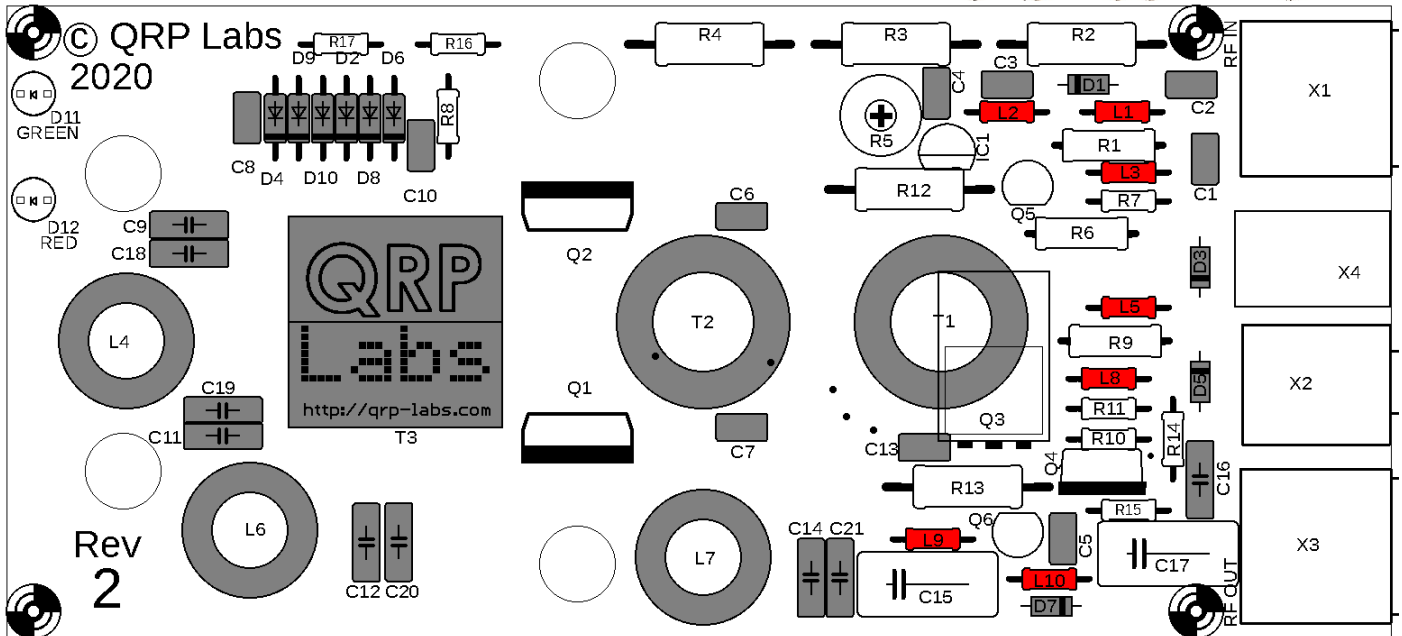

3.18 Install resistors R7, 10, 11, 14 and 17

These are 10K ¼W resistors, colour code brown-black-black-red-brown.

Bend the leads as shown, lying the resistors flat against the PCB.

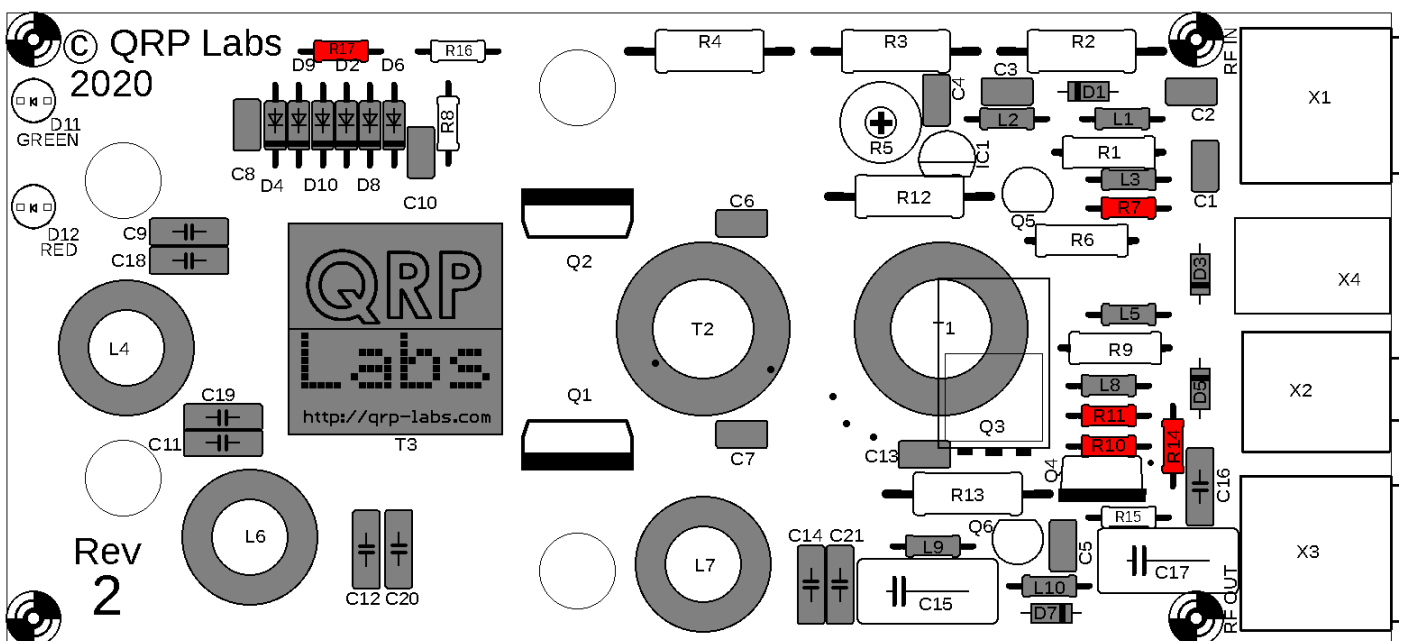

3.19 Install resistor R15

This is a 1.5K resistor, colour code brown-green-red-gold or brown-green-black-brown-brown.

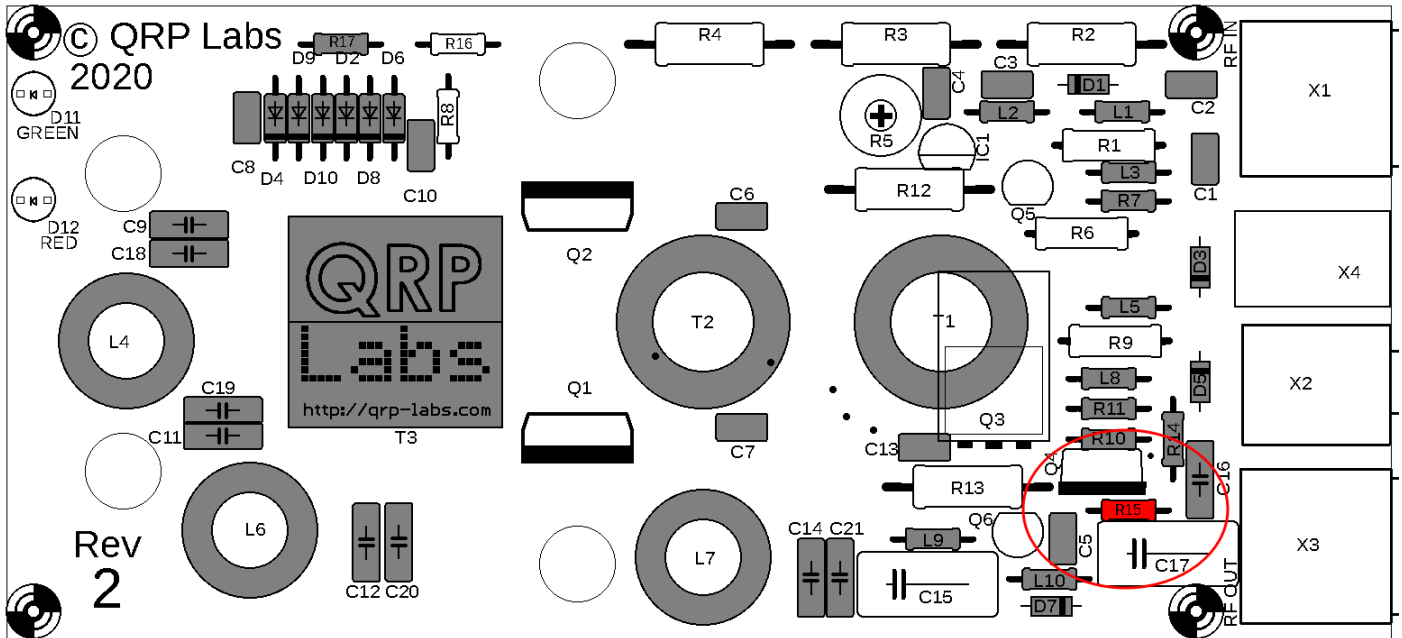

3.20 Install resistor R16

This is a 470-ohm resistor, colour code yellow-purple-black-black-brown.

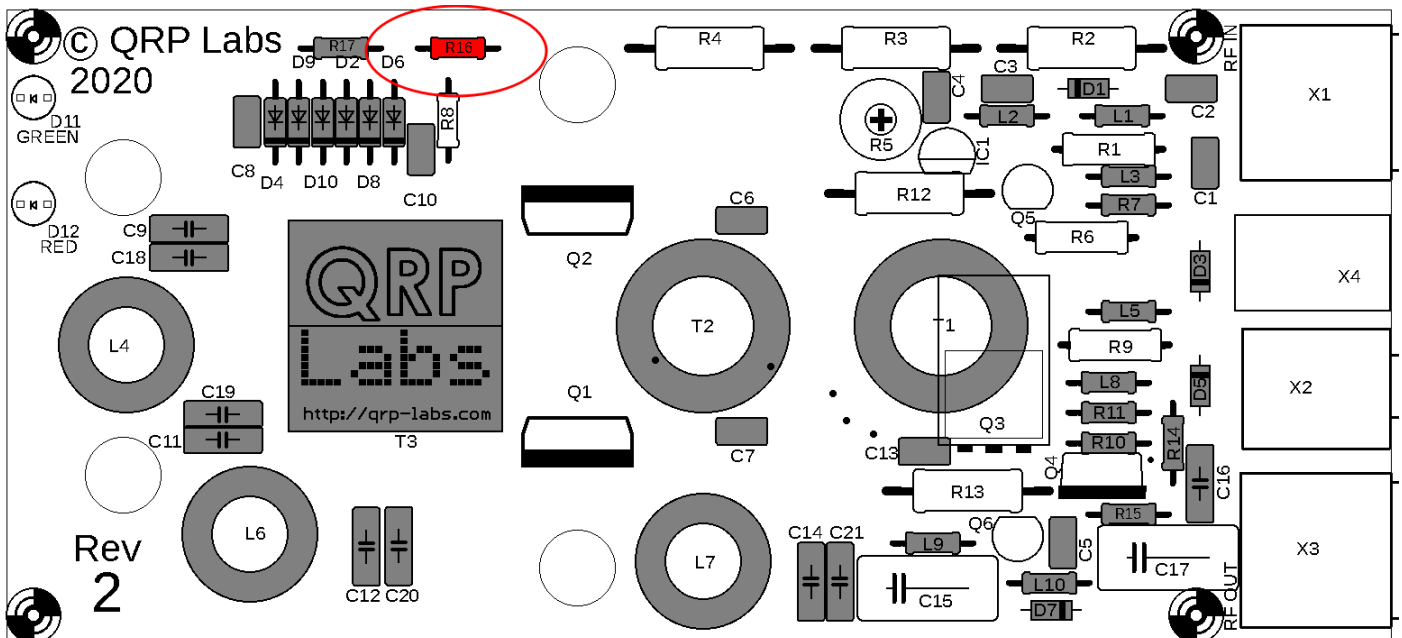

3.21 Install resistor R8

This is a 470K resistor, colour code yellow-purple-yellow-gold or yellow-purple-black-orange-brown.

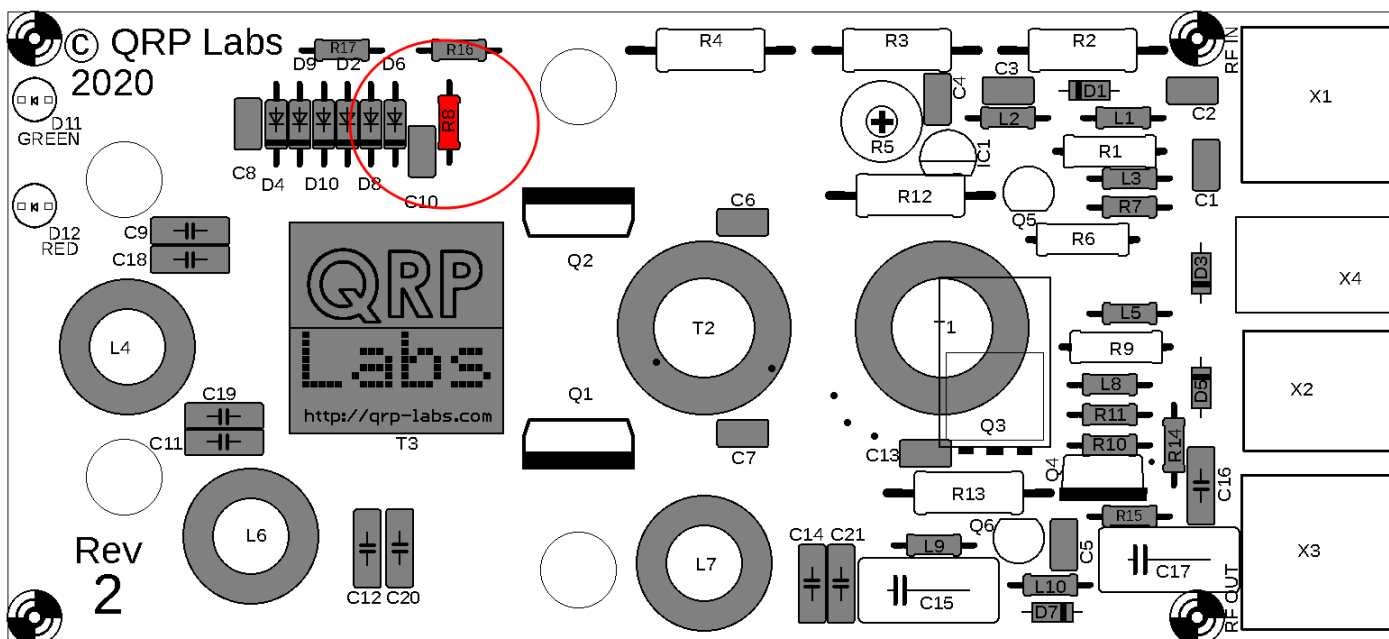

3.22 Install transistor Q3

This is the FQPF2N60C MOSFET in an all-plastic TO220 package, which is installed on the underside of the PCB.

It is important to install the transistor with the correct orientation as shown. Bend the wires as shown. Solder the wires on the top side. You can also add some solder on the bottom side pins but it is not necessary.

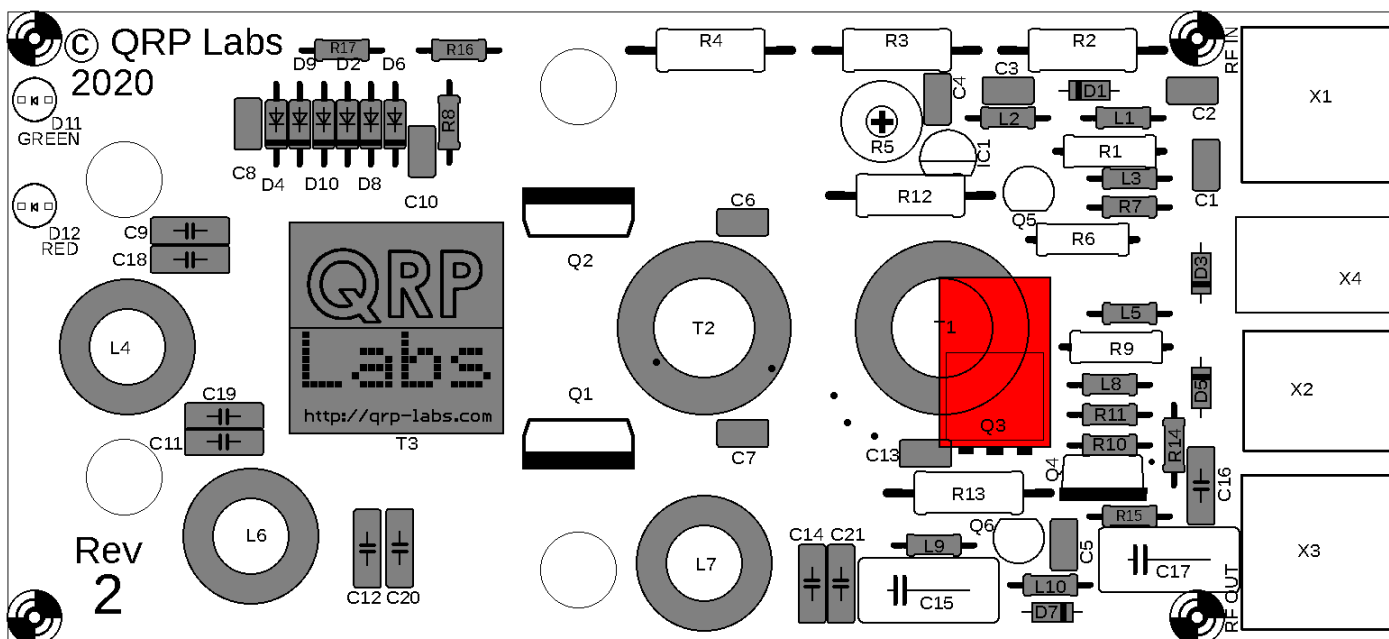

3.23 Install transistor Q4

This is an IRFu9024 transistor in an SMD-leaded package which is installed here like an ordinary through-hole transistor.

Make sure the transistor is aligned correctly: the metal face of the transistor must match the thick white line on the PCB silkscreen print.

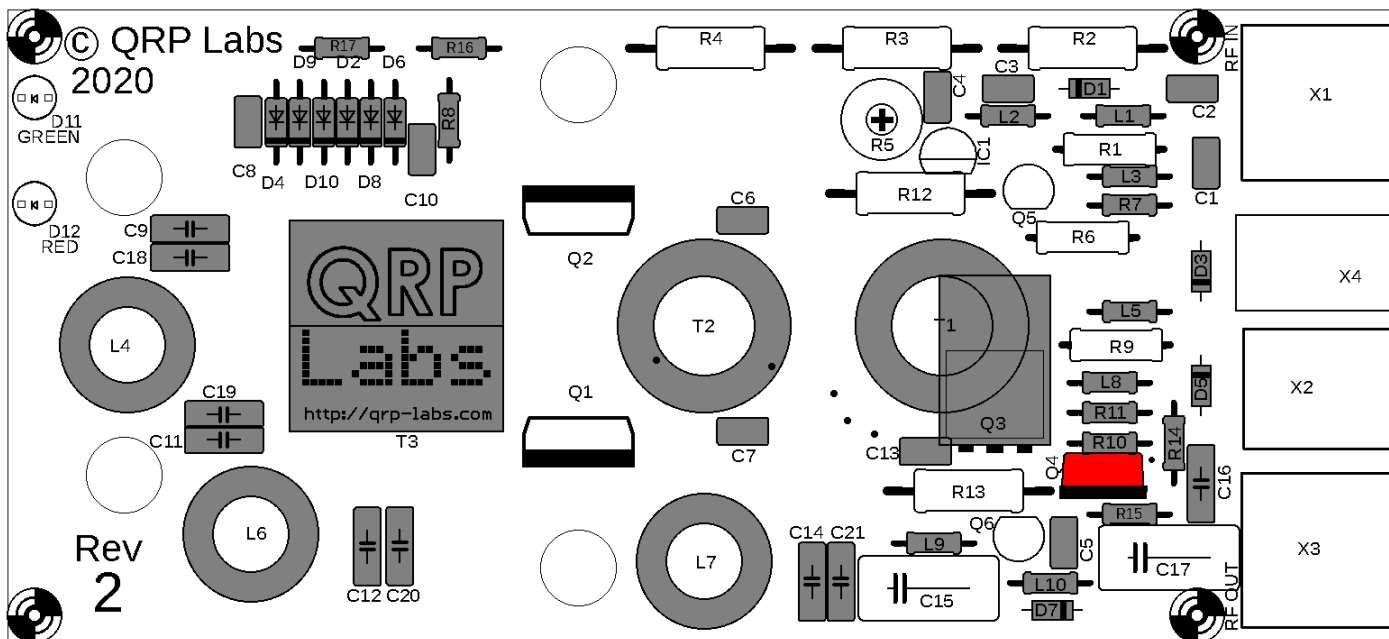

3.24 Install transistors Q5 and 6

These are BS170 MOSFETs in TO92 packages. Be very careful to check that the transistors you pick really are the BS170, since IC1 (78L05) looks exactly the same except for the different writing on the label.

The middle pin needs to be pushed forward slightly to match the holes in the triangular pattern on the PCB. Make sure the flat of the transistor body is aligned perfectly with the flat on the PCB silkscreen. It's not necessary to push the transistor all the way in, a lead length of 5mm or so is fine.

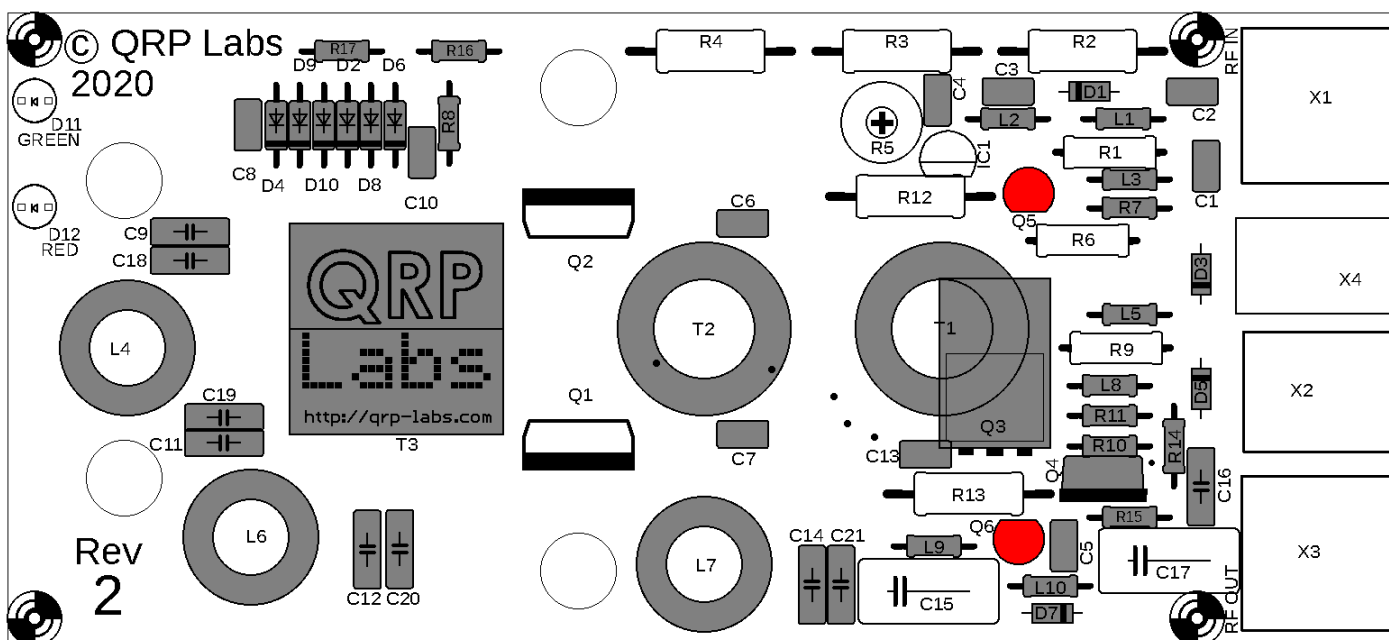

3.25 Install IC1

IC1 is a 5V voltage regulator, type 78L05, in a TO92-like package.

The middle pin needs to be pushed forward slightly to match the holes in the triangular pattern on the PCB. Make sure the flat of the IC body is aligned perfectly with the flat on the PCB silkscreen. It's not necessary to push the IC all the way in, a lead length of 5mm or so is fine.

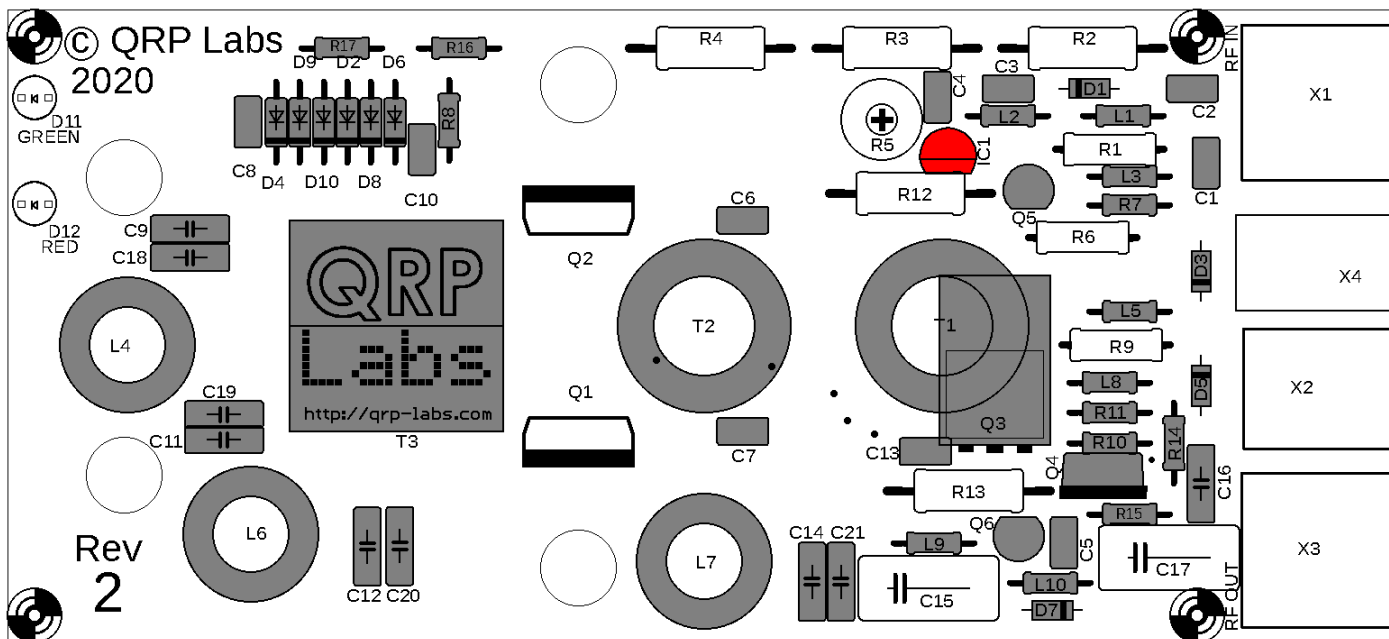

3.26 Install resistors R1, R6 and R9

These are 1K 1W resistors with colour code brown-black-red-gold or brown-black-black-brown-brown.

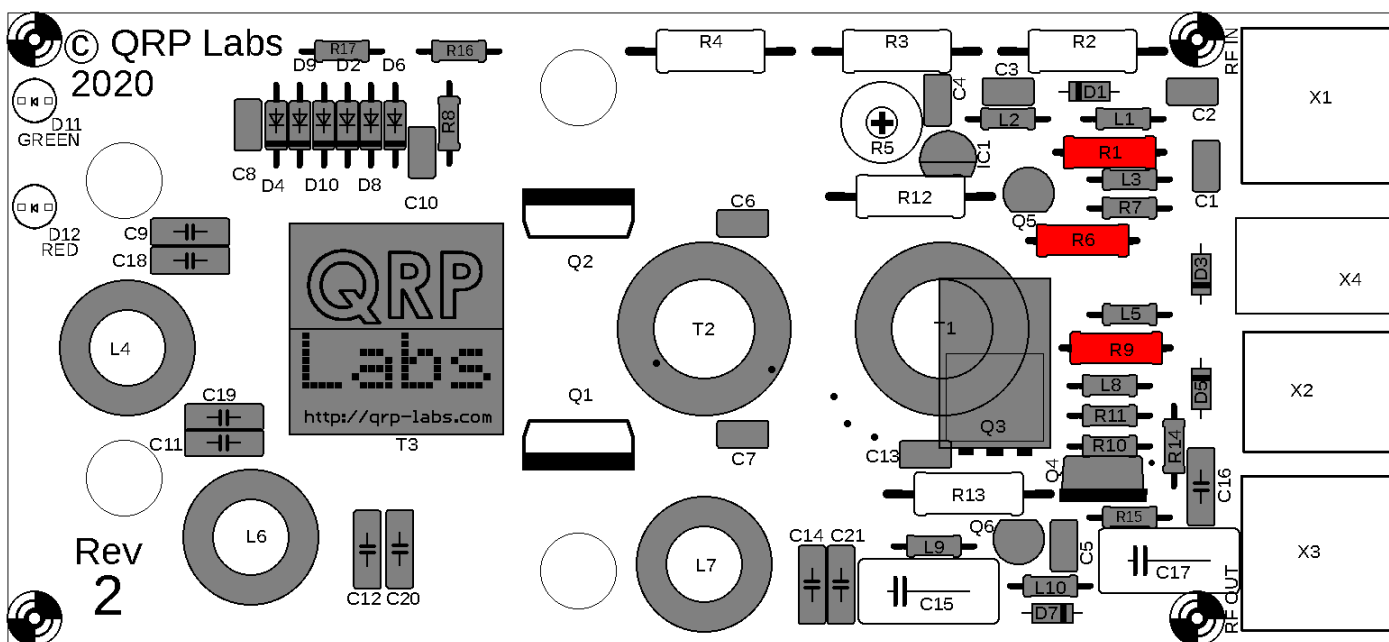

3.27 Install resistors R12 and R13

These are 470-ohm 2W resistors with colour code yellow-purple-brown-gold or yellow-purple-black-black-brown.

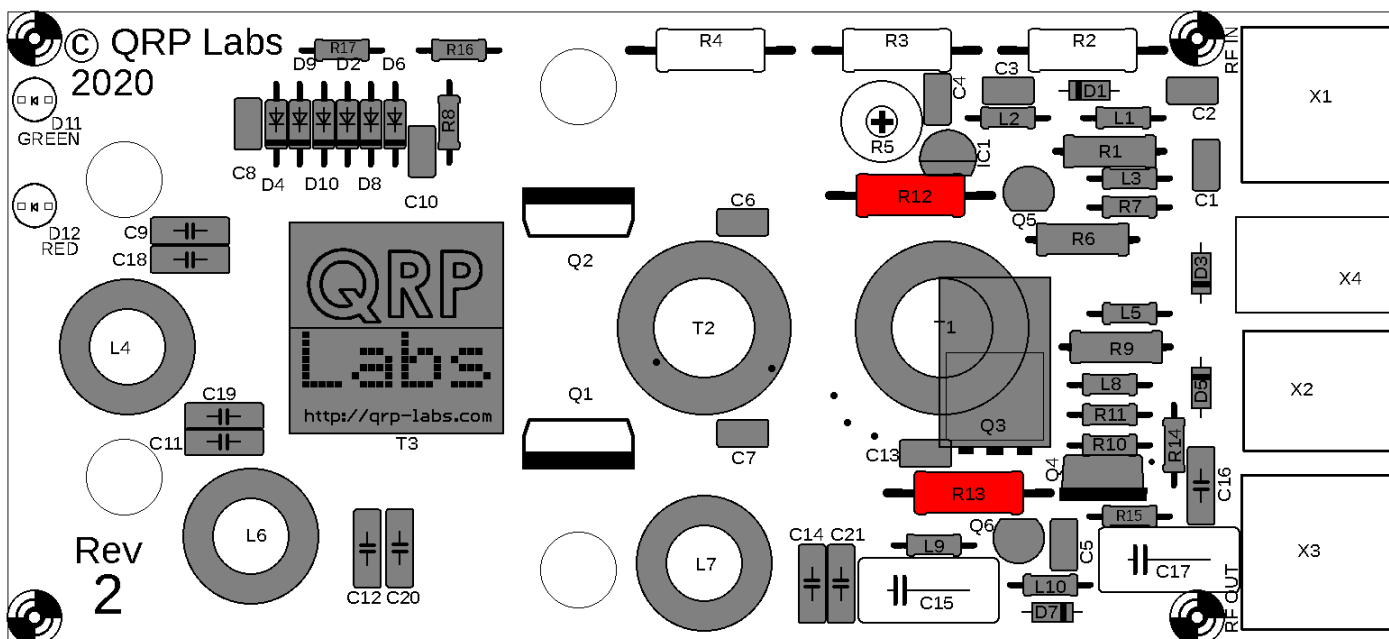

3.28 Install resistor R3

This is a 22-ohm 2W resistor, colour code red-red-black-gold or red-red-black-gold-brown.

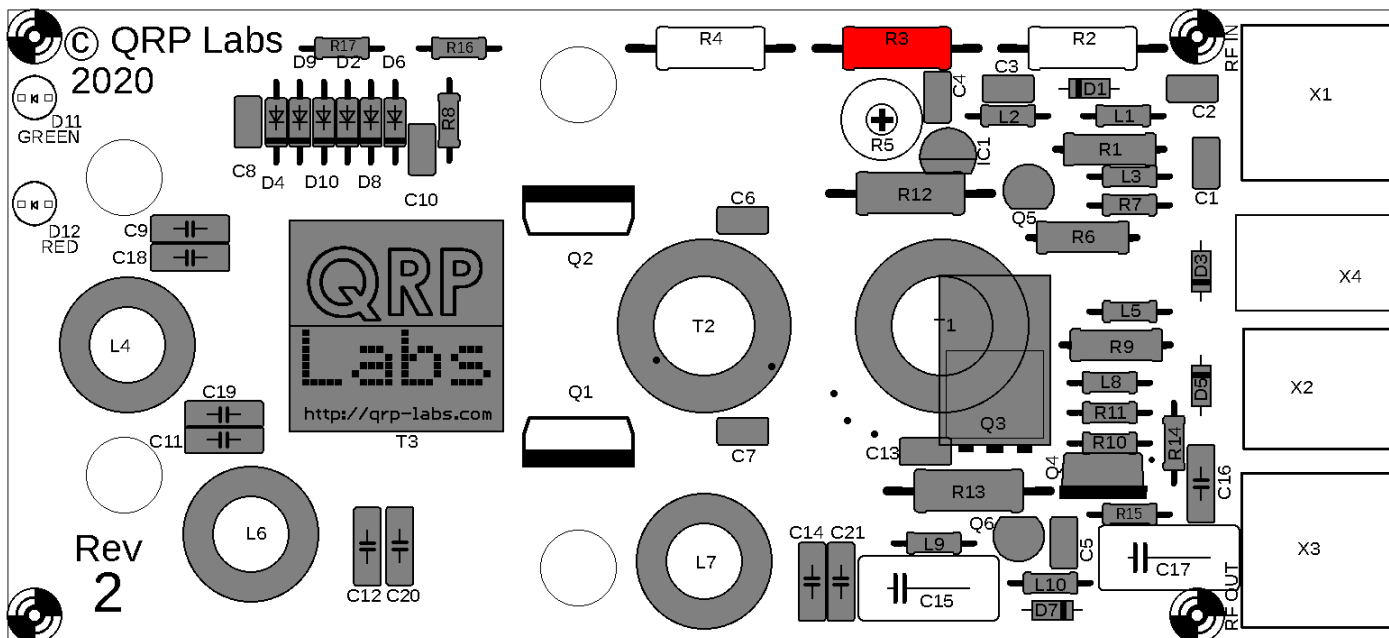

3.29 Install resistors R2 and 4

These are 330-ohm 2W resistors, colour code orange-orange-brown-gold or orange-orange-black-black-brown.

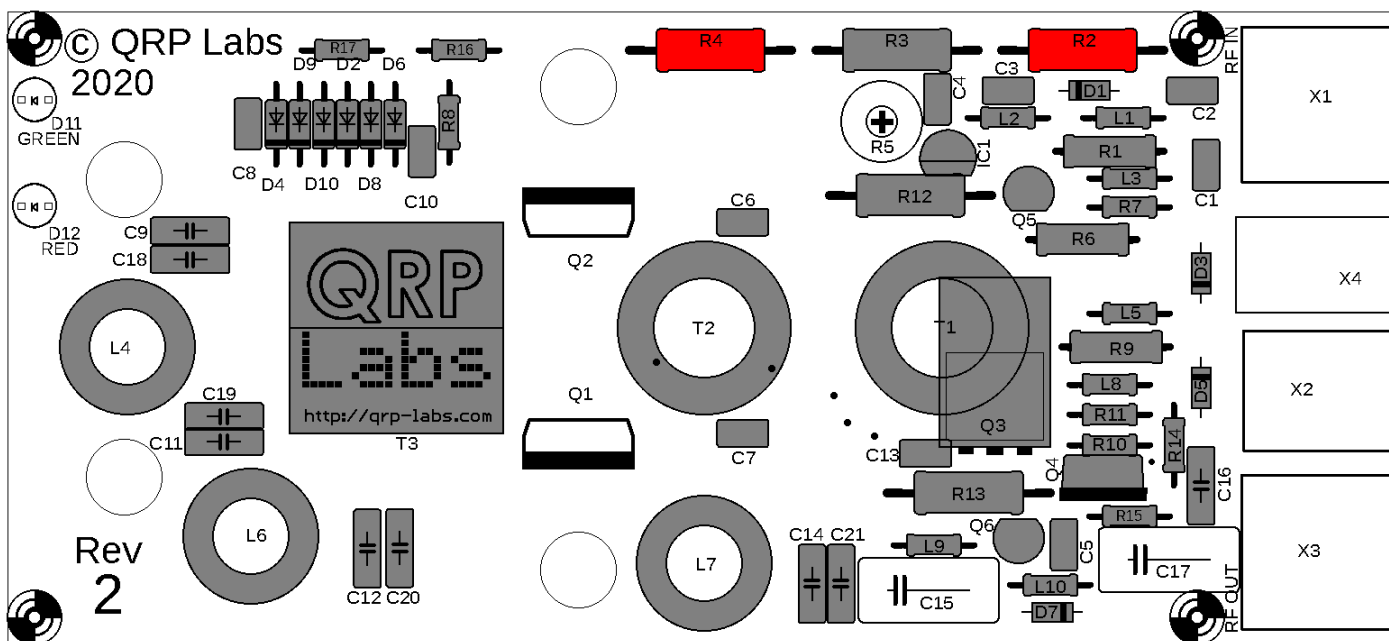

3.30 Install trimmer resistor R5

This is a 4.7K linear trimmer potentiometer. Push the potentiometer pins gently but firmly into the PCB and solder the three terminals.

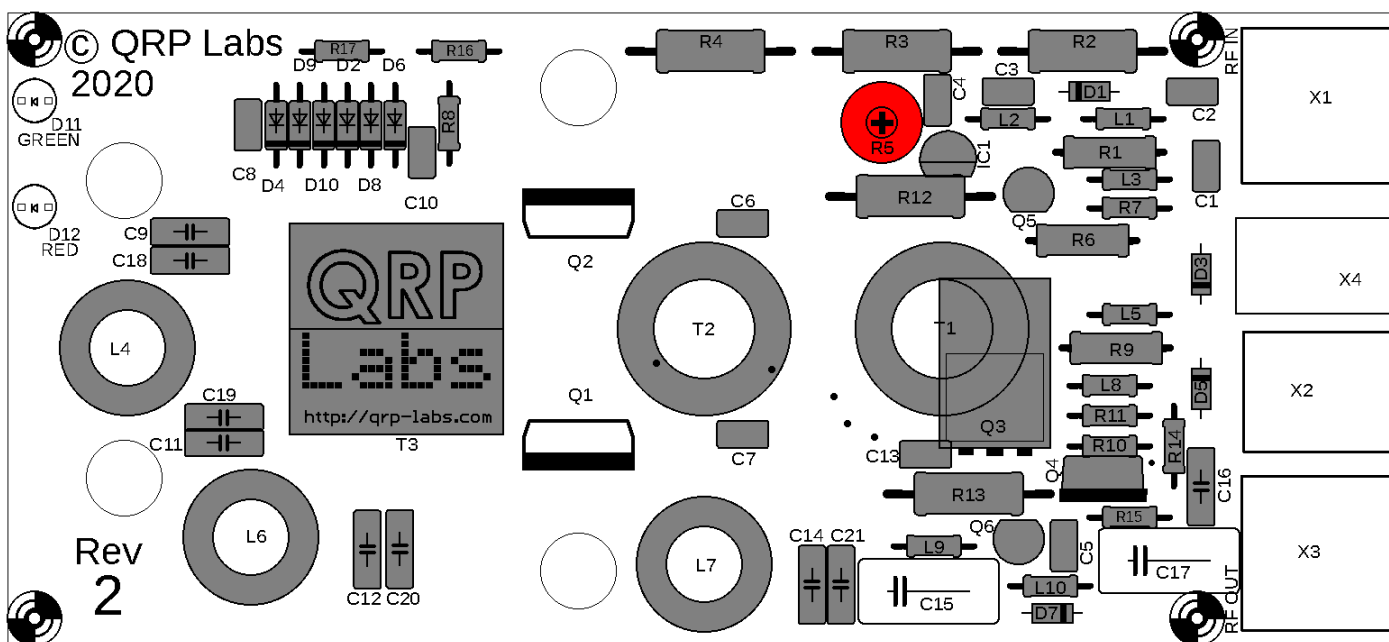

3.31 Install capacitors C15 and 17

These are 250V 0.33uF capacitors. They were installed last because they are bulky and would make accessing smaller components more difficult.

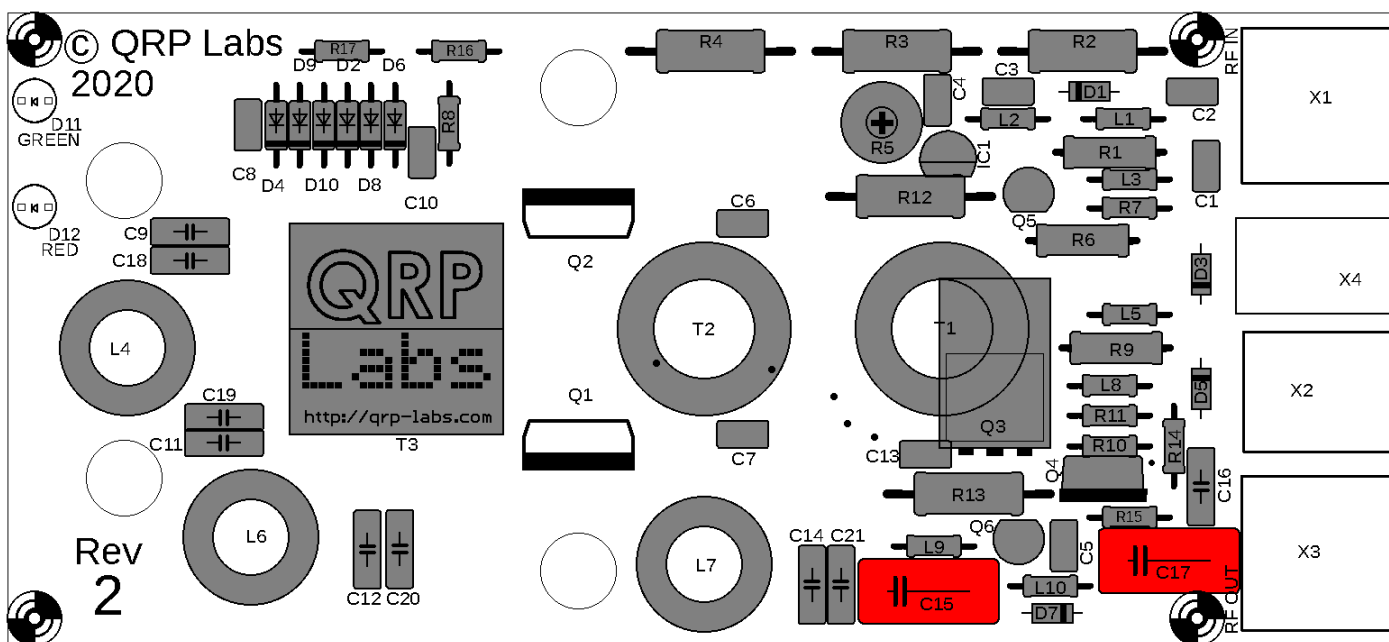

3.32 Install connector X4: DC Power in

X4 is a 2.1mm barrel connector for supplying DC power input. The PCB holes are quite large so the connector must be installed carefully to align it properly with the outline on the PCB silkscreen. This is particularly important if you are planning to install the amplifier in the optional QRP Labs enclosure, so that the plug barrel fits through the hole in the rear panel and into the socket. If the alignment is not accurate, the hole and the barrel will not line up correctly.

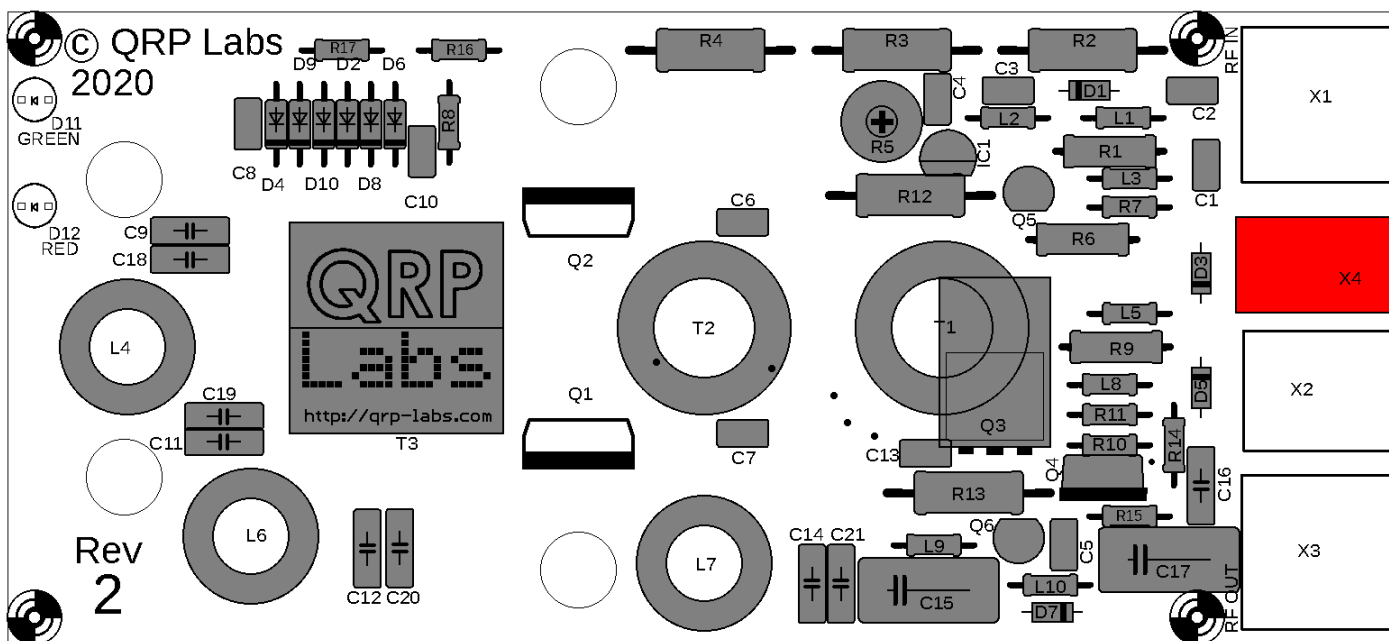

3.33 Install connector X2: PTT (key)

X2 is a 3.5mm jack socket. This is used for supplying the PTT (key) signal to the amplifier to switch it to Transmit mode. The connector is a bit of a tight fit and again, please ensure accurate alignment with the outline on the PCB silkscreen. This is particularly important if you are planning to install the amplifier in the optional QRP Labs enclosure, so that the socket barrel fits through the hole in the rear panel. If the alignment is not accurate, the hole and the barrel will not line up correctly. Note: two of the pads are very close together and you may easily create a solder bridge between them: don't worry! These pads are connected by a trace anyway!

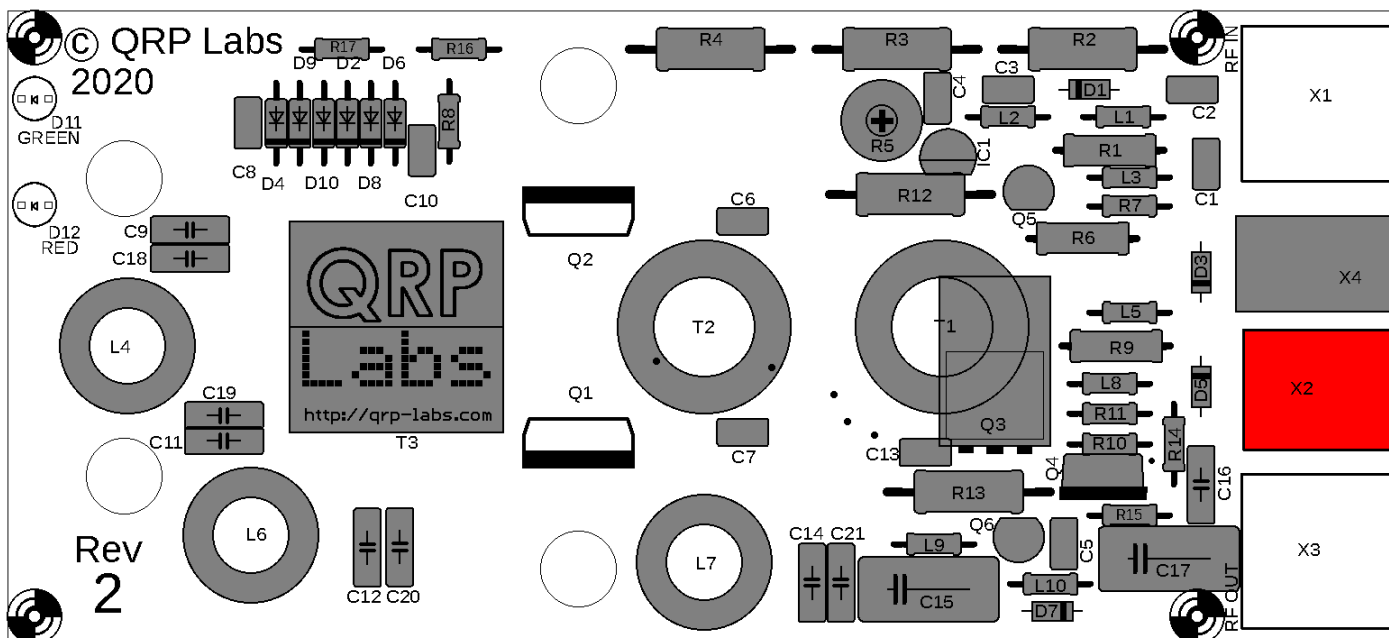

3.34 Install connector X1 and 3: RF In and Out

X1 and X3 are BNC connectors for RF input and RF output. Ensure accurate alignment with the PCB silkscreen so that the connectors line up perfectly with the rear panel of the QRP Labs enclosure. The ground and center pin connections should be soldered first; when you are 100% happy with the alignment, then solder the two mounting posts too.

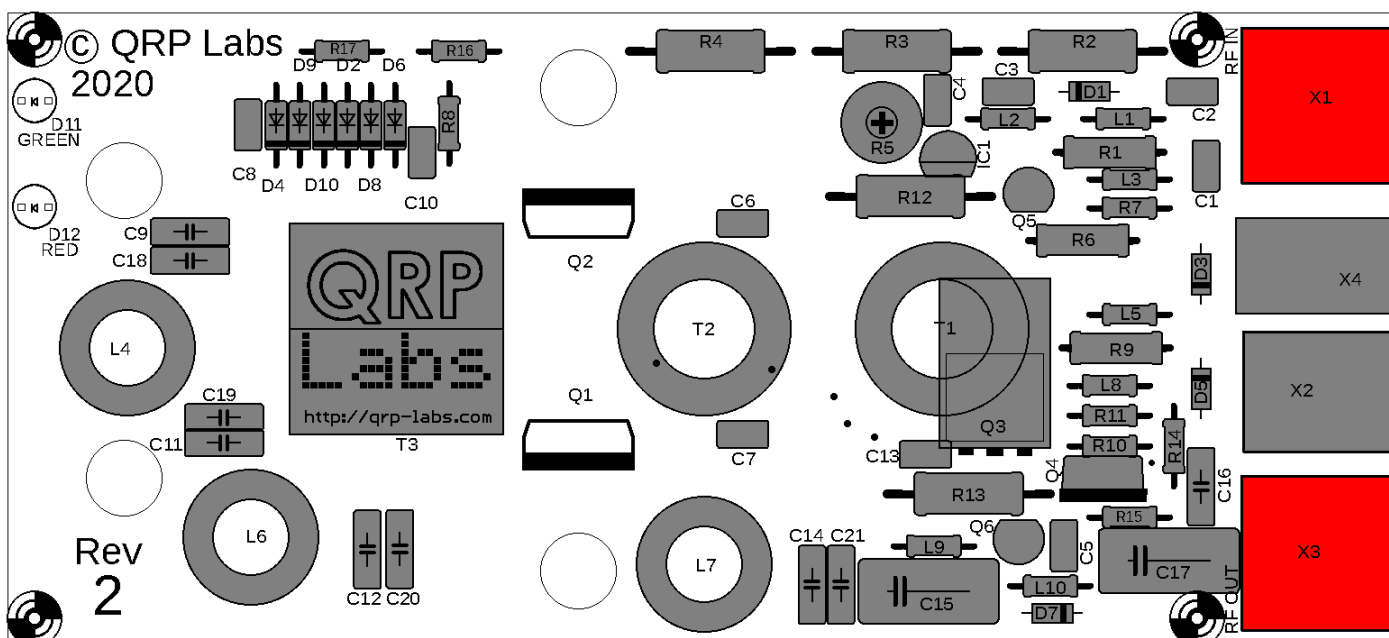

3.35 Install LEDs D11 and 12

D11 is a 3mm Green LED (DC Power on) and D12 is a 3mm Red LED (Transmit).



Identify the wire which is next to the flat on the LED body. This is also the shorter of the two wires. Bend this wire 90-degrees down, right at the body of the LED. Then bend the other wire down also, but at a distance of 0.1-inches from the LED body. Do the same thing for both LEDs.

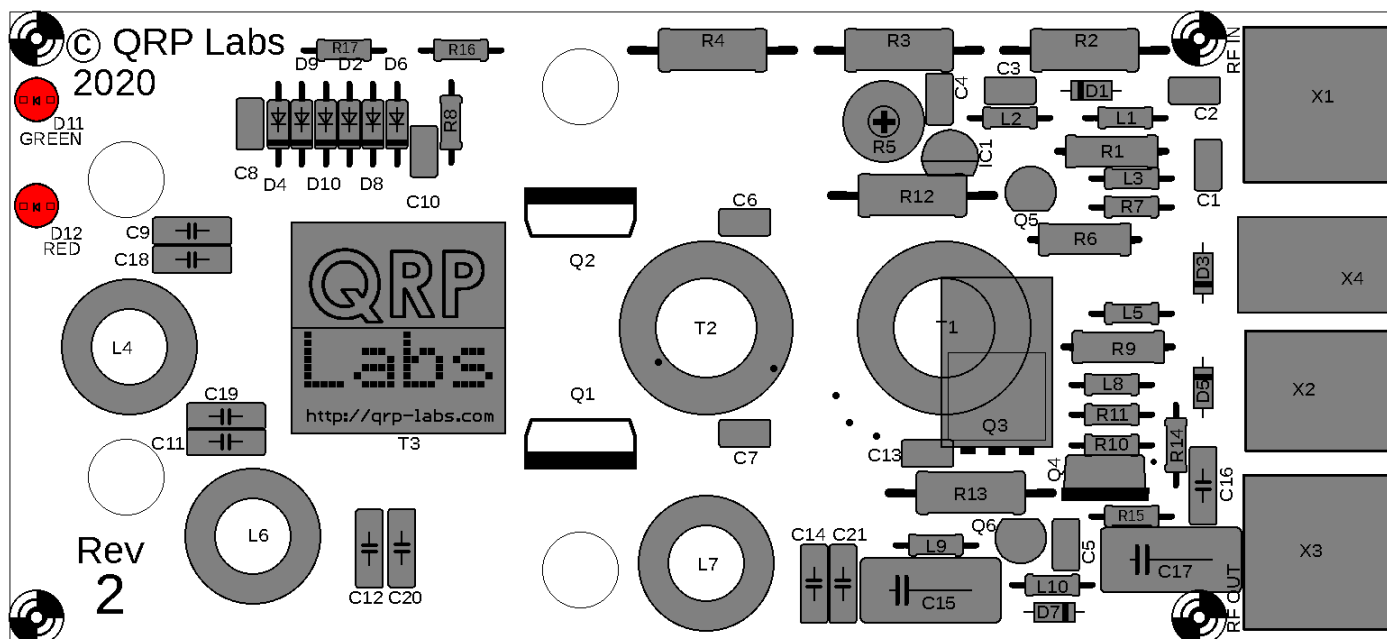

Install the LEDs as pictured, sitting with their flats right on the PCB. This will ensure that if used with the optional QRP Labs enclosure, the LEDs will align perfectly with the holes in the enclosure front panel.

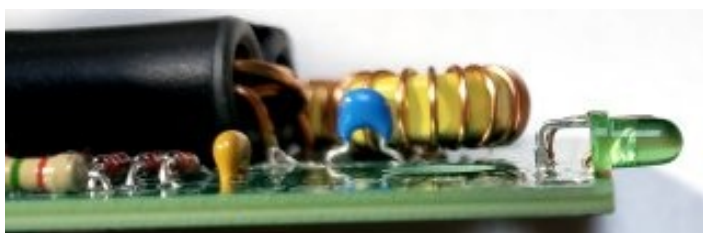

Hopefully the assembly now looks something like this:

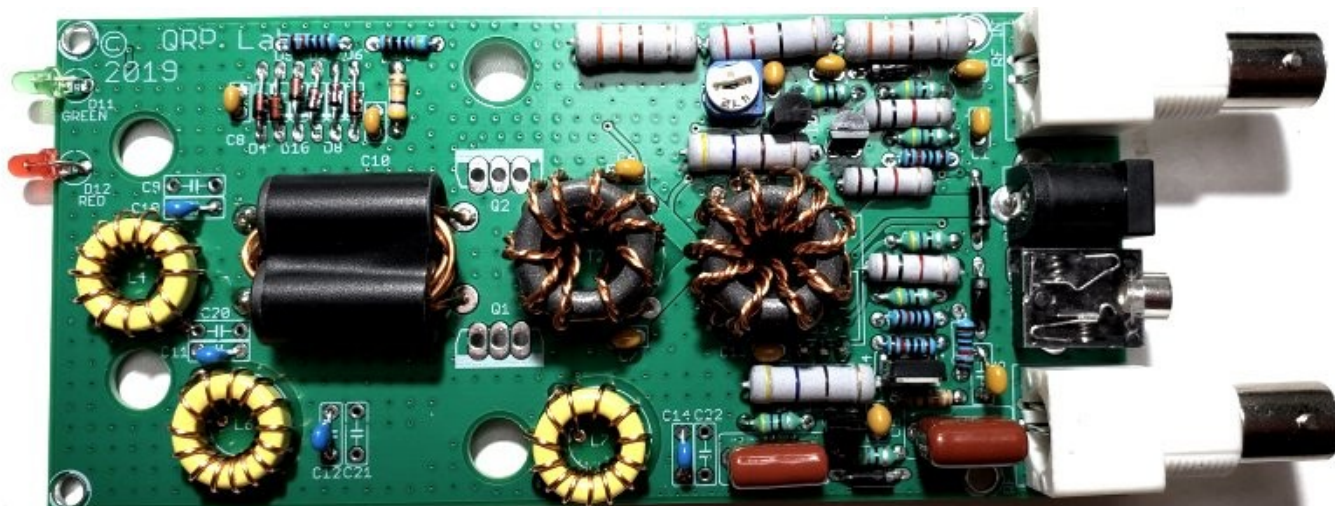

4 NO ENCLOSURE OPTION: PA Transistor installation

If you did NOT purchase the enclosure, now is the time to install the IRF510 transistors, Q1 and Q2. **Only if NOT using the QRP Labs enclosure!**

Bend the pins upward of the IRF510 90-degrees right at the body of the IRF510. Make sure to bend them upward not downward; you only get one chance at this – if you bend them the wrong way then try to correct it, the pins may well break off.

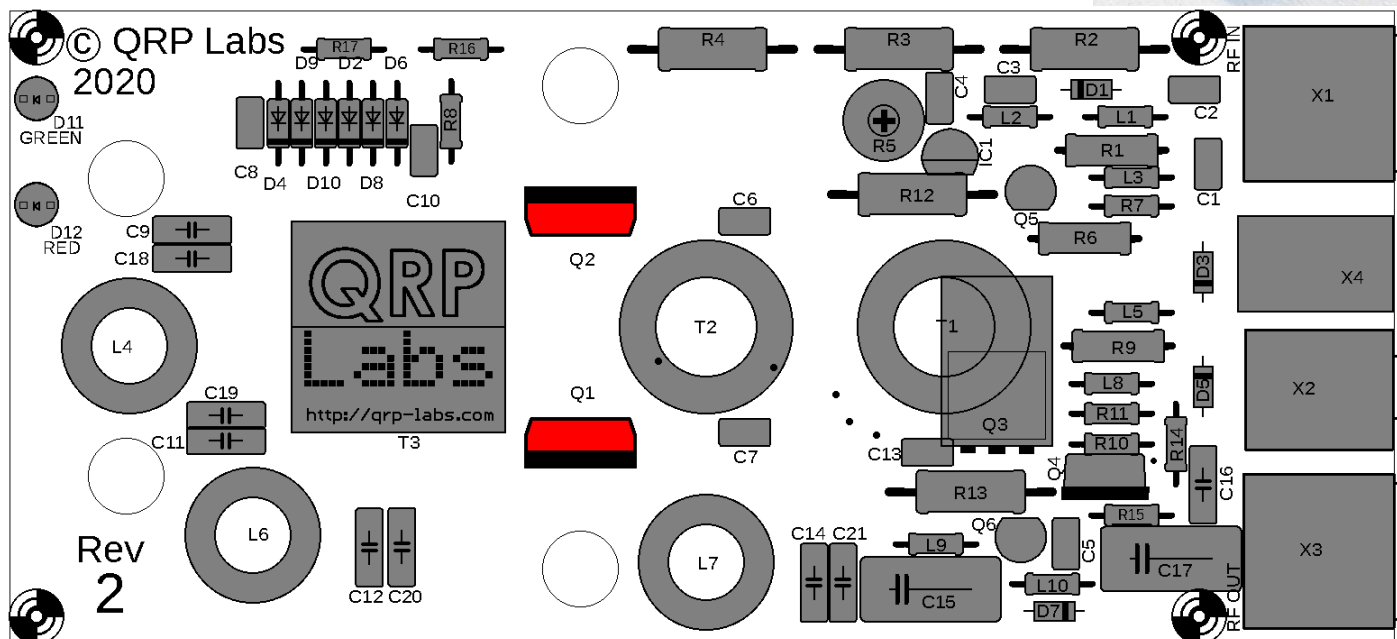

Install the transistors on the underside of the PCB and solder the pins on the top side. The underside of the PCB should now look like this:

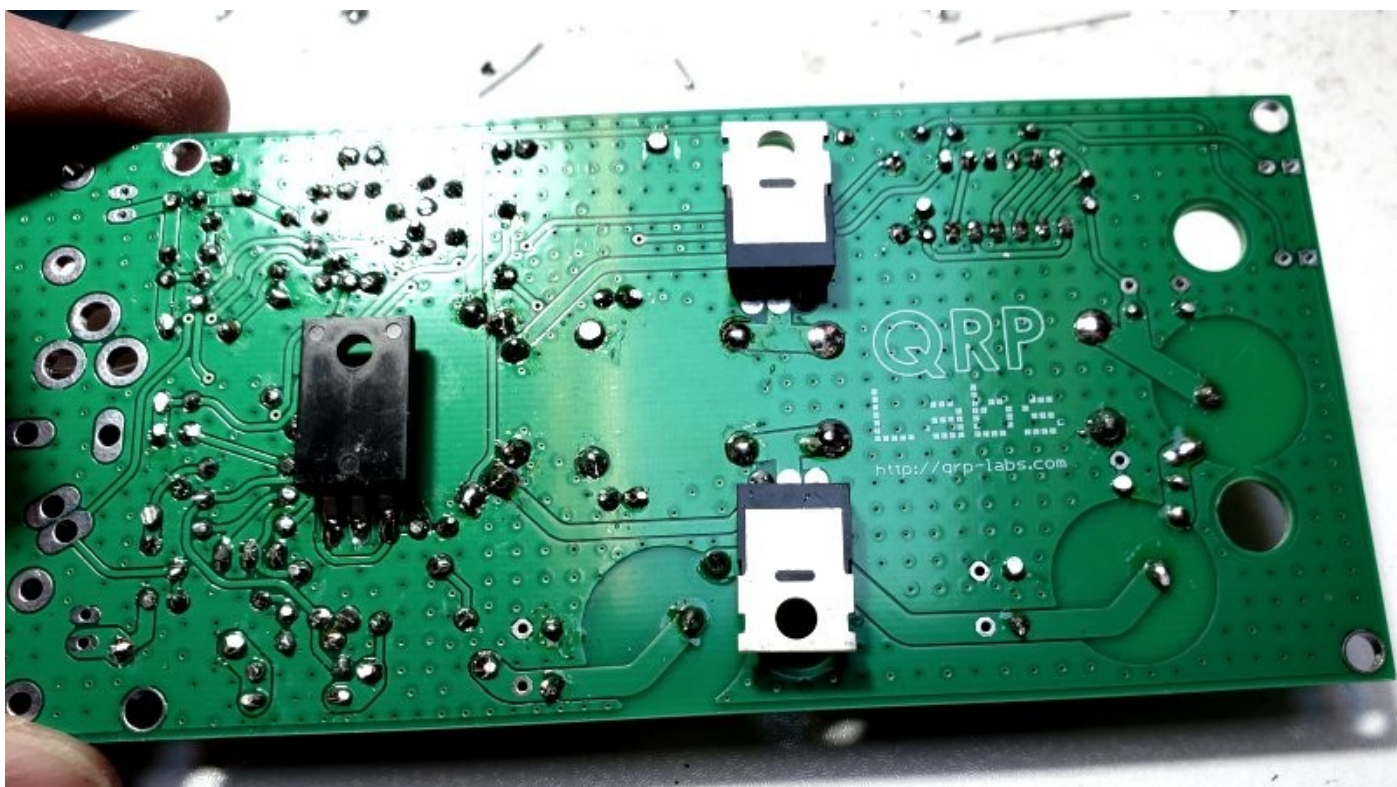

Position the heatsinks side-by-side as shown below:



Apply the blue silicone pads as shown here:

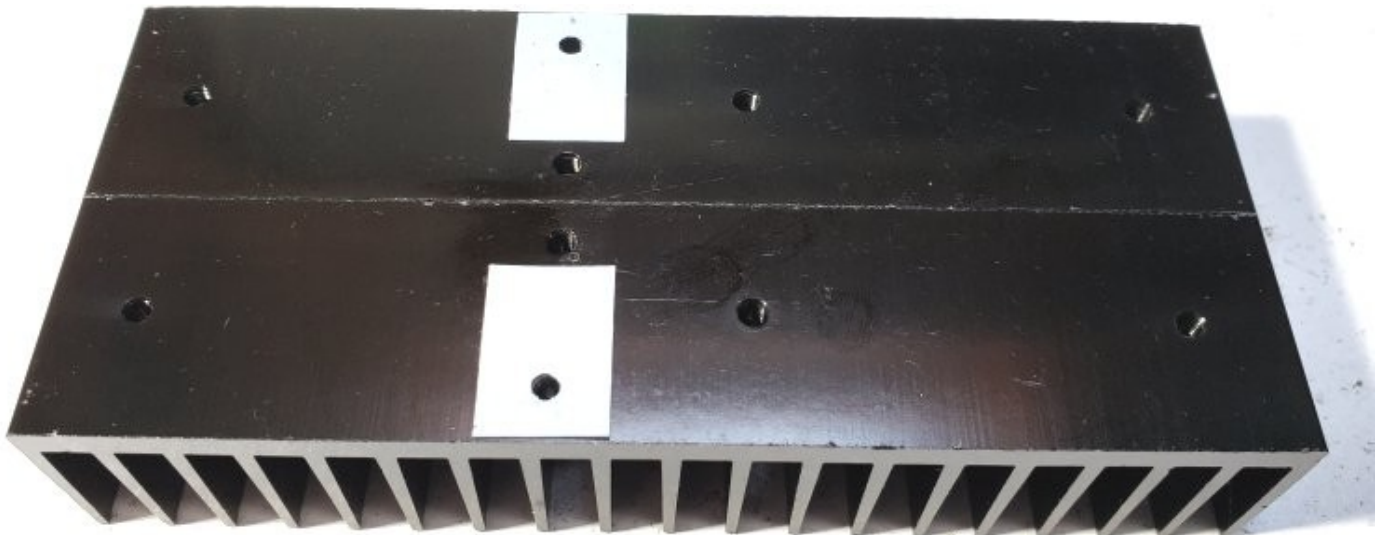

Bolt the PA assembly to the heatsinks with two bolts with insulating white plastic washers (see right).

The only mounting point in this case is the IRF510 tabs. This is not ideal mechanically and you really should consider using a proper enclosure.

Use a DVM, with one probe held in the screw head, and the other touched to the central pin of each IRF510. You should see NO continuity in either case. This is critical! The drain of the transistor is connected to the tab. If there is a short from the tab to the heatsink, the amplifier will fail; it means the silicone and screw has a short somewhere.



The final completed 50W Amplifier kit should look like this:



5 ENCLOSURE OPTION installation

When using the QRP Labs enclosure designed specifically for this 50W PA kit, the IRF510 power transistors must first be bolted to the enclosure assembly, BEFORE soldering to the PCB. Otherwise there will be a small gap (around 1mm) between the enclosure/heatsinks and the IRF510 tab. Tightening the mounting bolt to eliminate that gap would put undue mechanical stress on the situation.

The enclosure consists of an extruded top piece (drilled for the heatsink), plain bottom section, front and rear panels, 8 panel screws, and 4 self-adhesive rubber cabinet feet.

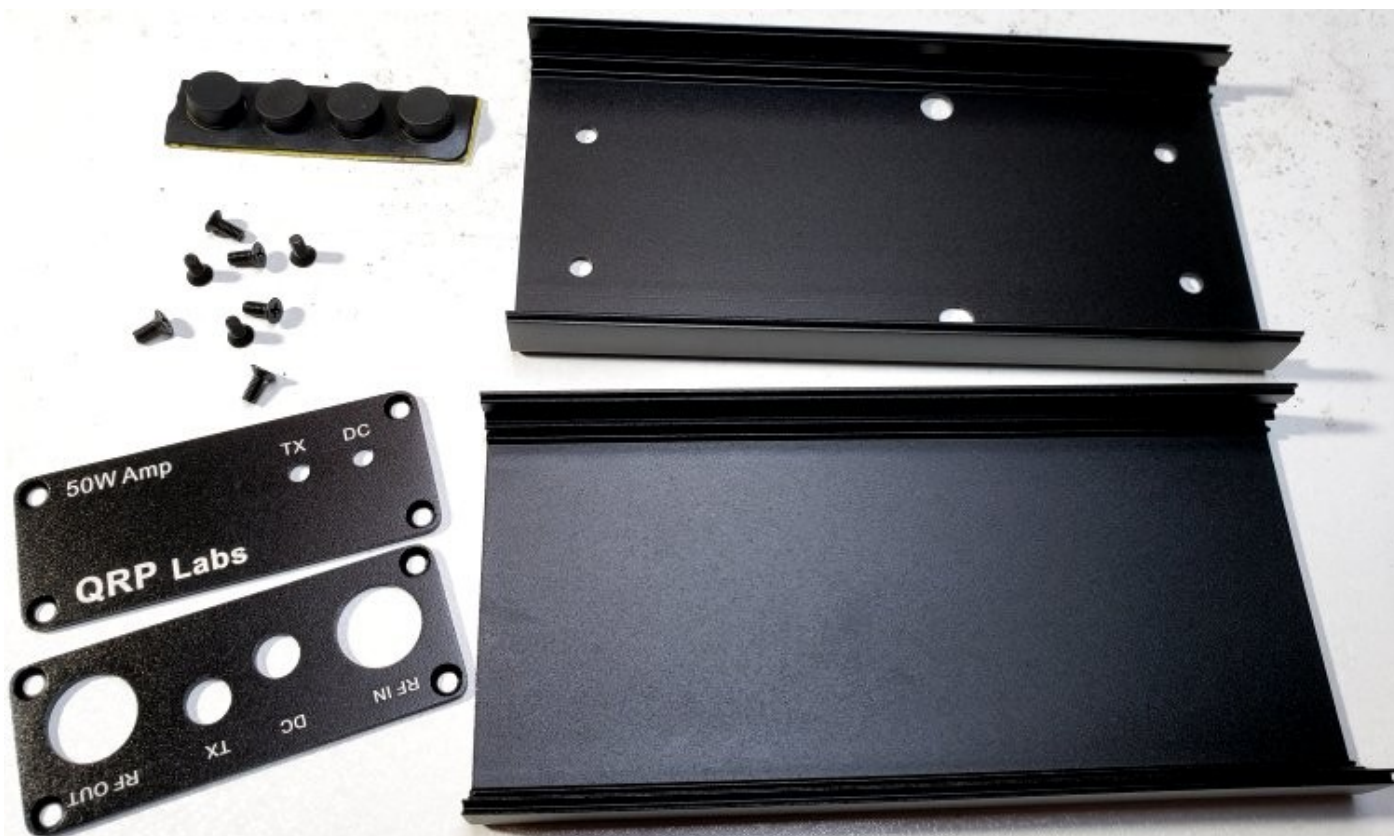

Place the heatsinks side-by-side as shown. The enclosure top will be bolted to the heatsinks with 6mm M3 screws in holes 1, 2, 5 and 6. Holes 3 and 4 will be used to bolt the IRF510's to the heatsink. The remaining holes of the heatsink are not used in this application.

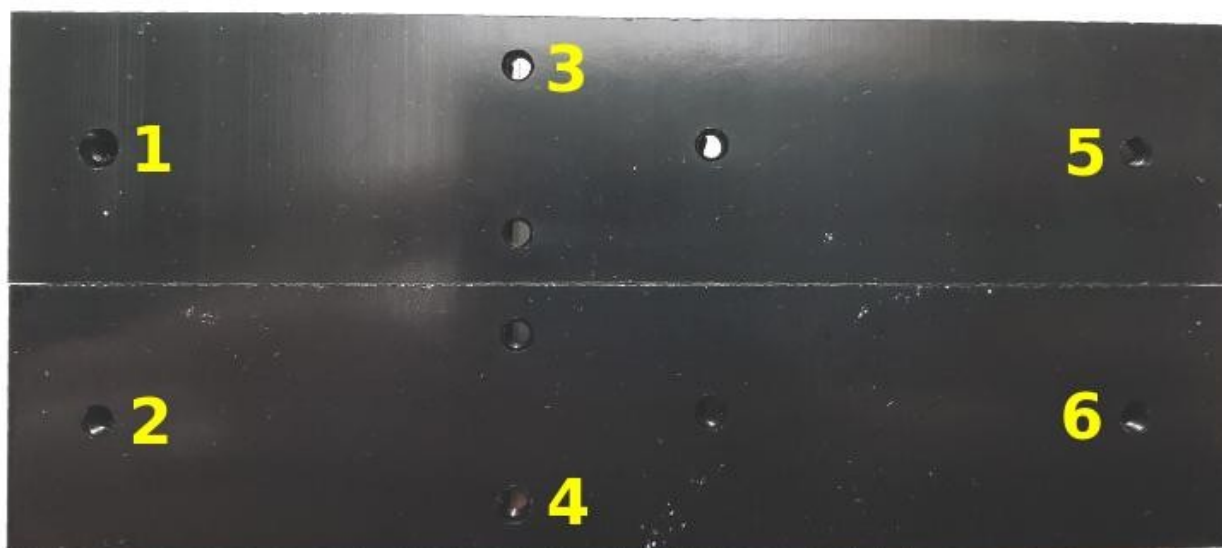

Bolt the heatsinks to the outside surface of the top of the enclosure using two 6mm M3 screws on the right-hand side (holes 5 & 6); these are the holes which are FURTHEST from the central holes 3 & 4. Tighten these screws but make sure that the heatsinks sit squarely on the lid of the box, and the heatsink holes line up with the holes in the enclosure lid.

Bend the pins upward of the IRF510 90-degrees right at the body of the IRF510. Make sure to bend them upward not downward; you only get one chance at this – if you bend them the wrong way then try to correct it, the pins may well break off.

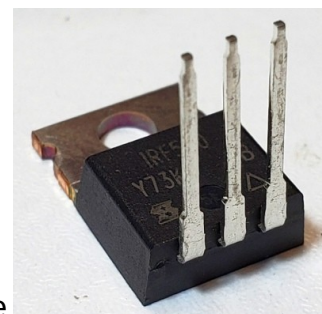

Place the light blue coloured silicone pads over holes 3 & 4. Make sure the hole in the pad is aligned with the hole in the heatsink. The pads need to be taped in place using small pieces of electrical tape. Otherwise they will move during the installation. Tape only around 1mm at the edges of the silicone pad. Do not overlap the tap and silicone pad by more than 1mm. With this small overlap, the IRF510 will fit comfortably between and sit only on the silicone pad, as shown in the photograph below, where an IRF510 is placed on the lower pad.

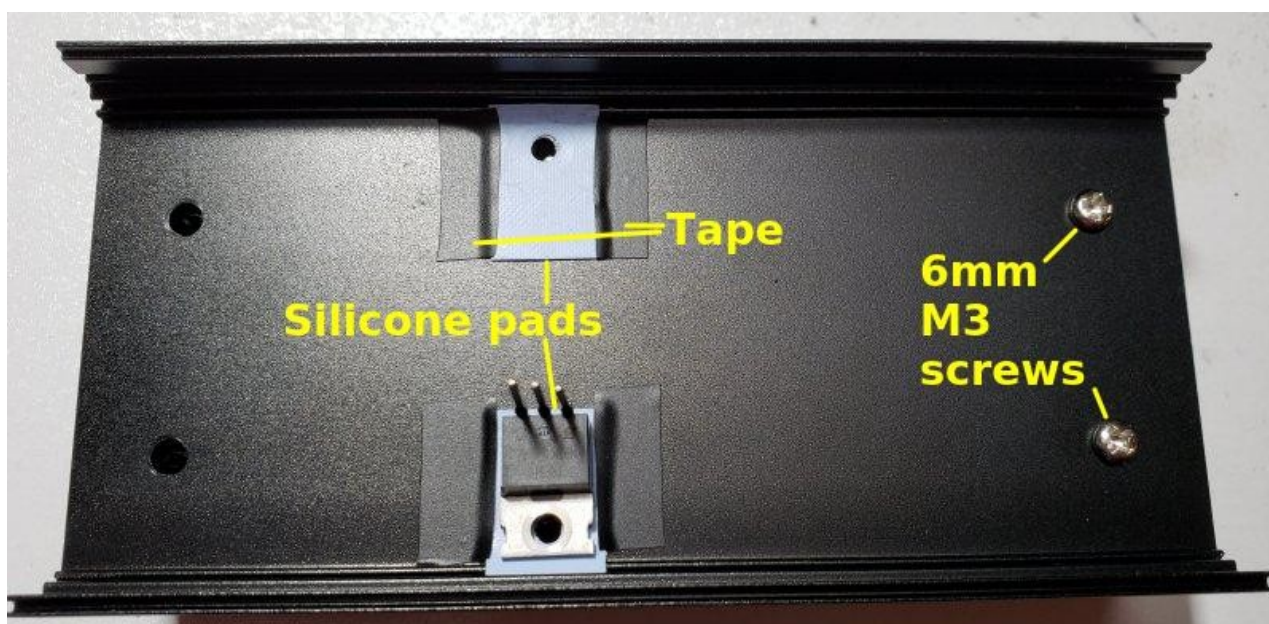

Place the IRF510 transistors through the PCB holes on the underside of the PCB, as shown below. **DO NOT SOLDER!**

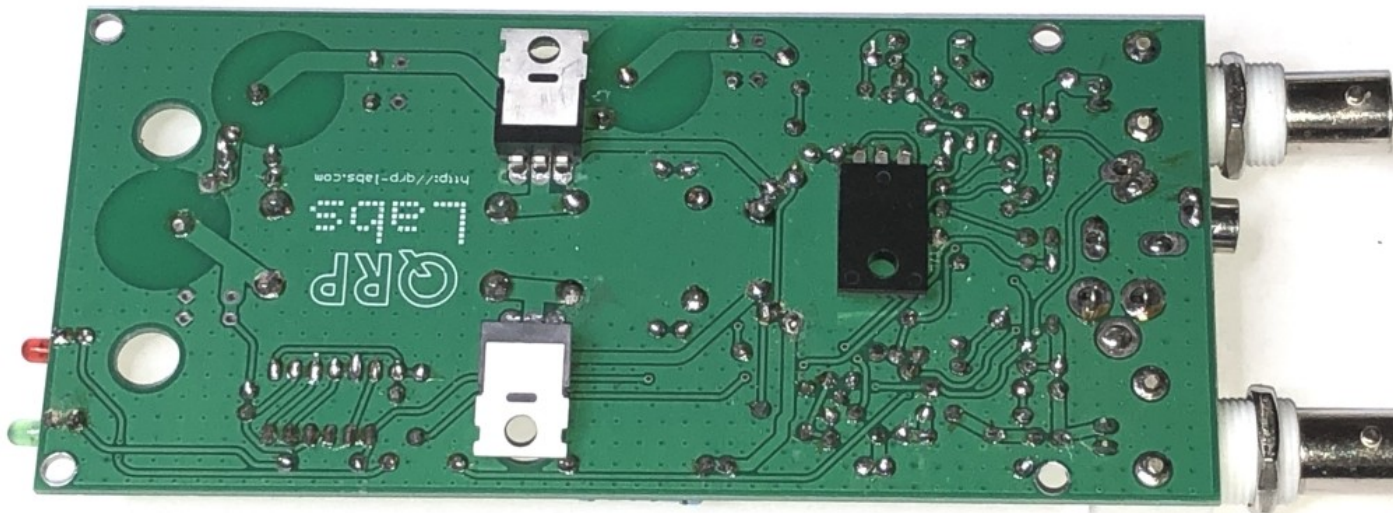

Turn over the heatsink/enclosure lid assembly, and slide the PCB carefully and slowly into the slots in the enclosure.

The PCB slots are shown here (right). By having the PCB upside-down the IRF510 transistors (which are NOT yet soldered) will fall away from the enclosure lid, allowing them to slide past the silicone pads.

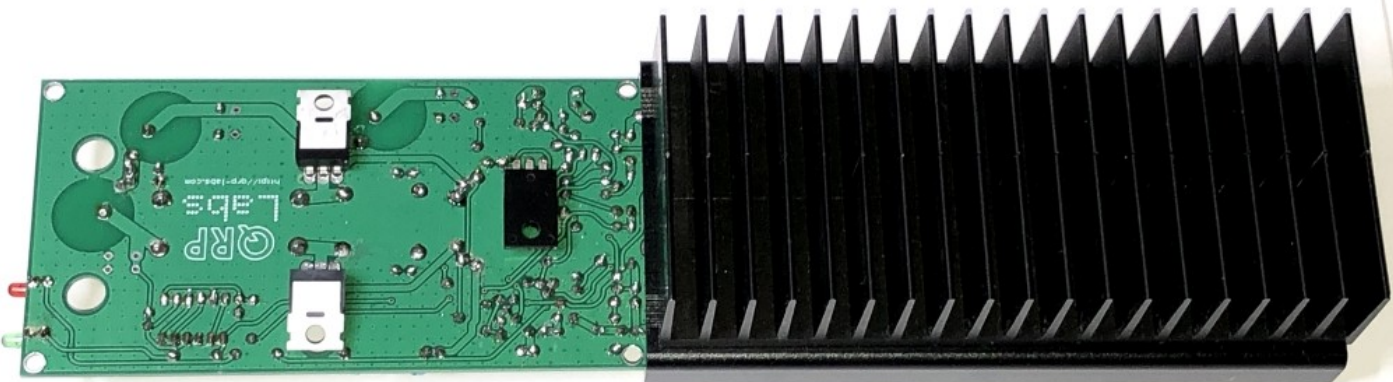
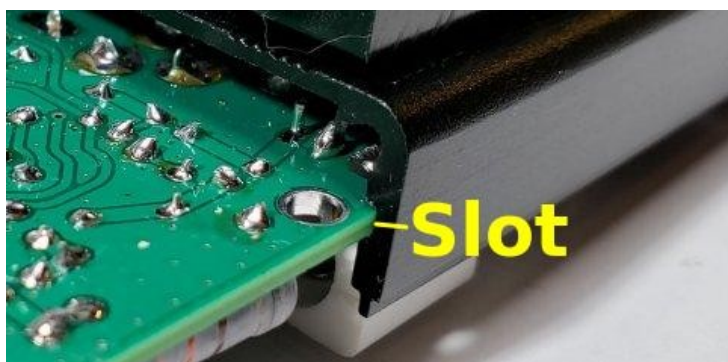

Eventually when the PCB is slid all the way in, you should be able to see through the IRF510 screw mounting hole, all the way through the silicone pad, to the heatsink hole. All lined up!

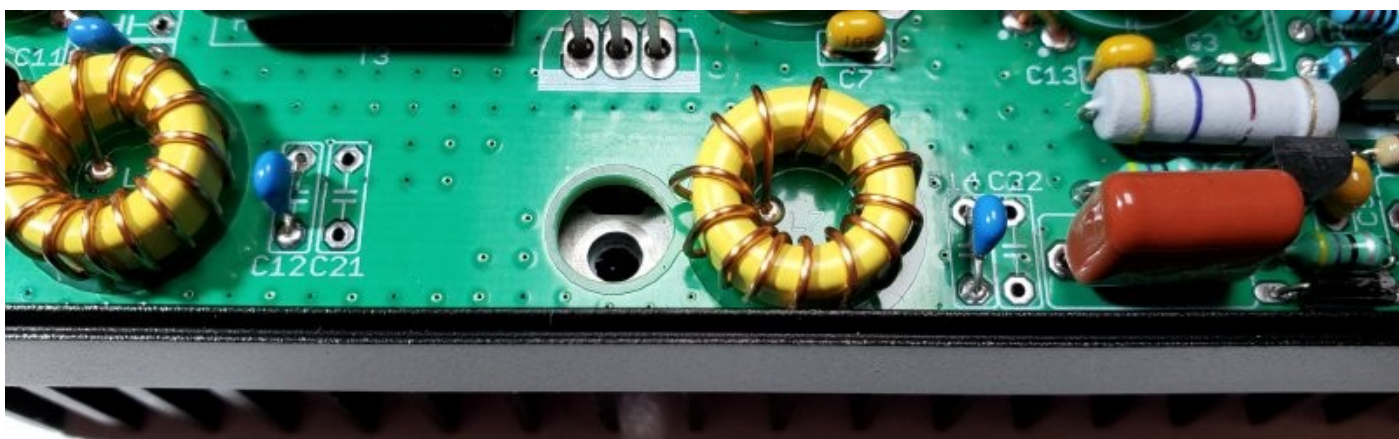

It's worthwhile trying to shine a strong light down and eyeball that narrow gap between PCB and enclosure, to see if it seems that everything is still in place (specifically: those silicone pads).

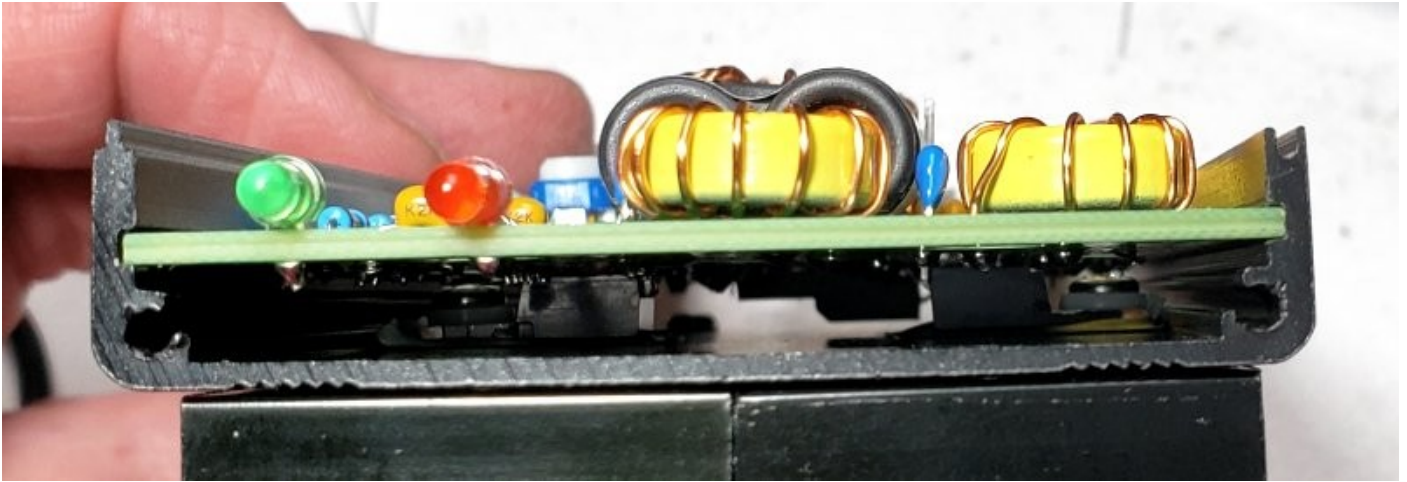

Now insert the final four screws. **STILL DO NOT SOLDER THE IRF510's!** The screws at the IRF510 tabs are 9mm M3 screws with the plastic insulating washer (see right). This is because the tab of an IRF510 is connected to the Drain, therefore is RF-hot... not what you want shorting to the enclosure ground or each other.



The two screws at the end of the PCB near the LEDs are 6mm M3.



Now test the insulation at the IRF510 tabs by putting one probe of a DVM in resistance (or continuity test) mode in the head of the top screw, and the other probe on the middle pin of the top IRF510 (Q2), which is the Drain. Be sure to touch the probe to the pin, not to the pad – remember you have not soldered yet so the connection at the pad could be expected to be intermittent. You should see NO CONTINUITY (infinite resistance). If you see a short-circuit it means that the silicone insulating pad has somehow NOT done its job properly and you need to definitely open everything up and fix that.

Repeat this test for the lower IRF510 (Q1) and its tab screw, making sure there is no continuity.

Once you are absolutely certain that there are no short-circuits, only then solder in the IRF510s. It is recommended to solder the rightmost pin of Q2 first (ground), followed by the center pin and then the left pin. This is because the ground pin is hardest to solder and will take the most heat; if

you have already soldered the center pin, you are at risk of creating a solder bridge and they are quite hard to remove.

Similarly, solder the leftmost pin of Q1 first (ground), followed by the center pin then the right pin. Check with the DVM for no short-circuits, AGAIN, after soldering.

Now the front and rear panels can be attached, using two screws in each panel to attach them to the lid of the enclosure. Note that the PCB is “upside down” when it is installed in the enclosure. It doesn’t mind. Remember, heat rises.



The bottom part of the enclosure is pressed into the top part and secured using four screws, two in the bottom corners of the front panel and two in the bottom corners of the rear panel (see below left). The top and bottom of the enclosure use a tongue-and-groove system on the long edges; what this means is that the enclosure will only fit together properly one way round. If you find it does not fit or the holes in the panel do not appear to line up properly with the holes in the extruded bottom section, then check that you have the bottom section the right way round! You might need to rotate it 180-degrees.

For now, DO NOT FIT THE BOTTOM part of the enclosure – you still need to complete the set-up of the amplifier, which involves adjusting the R5 trimmer potentiometer!

Fit the BNC connector nuts on the rear panel. They do not need the compression washers. There is no need to over-tighten the nuts. See below right.



The final step in the enclosure assembly is the addition of the four self-adhesive rubber cabinet feet on the bottom, one in each corner. See photograph below.



6 CIRCUIT EXPLANATION

The designer, Hans Summers G0UPL explains some of the details behind the circuit and choices made in the design and production of the kit.

In this section I will provide an explanation of the circuit sections, including design choices. Some of the design choices are made by a large number of experiments to determine the optimum configuration and component values experimentally.

6.1 Schematic

The schematic is shown on the following page.

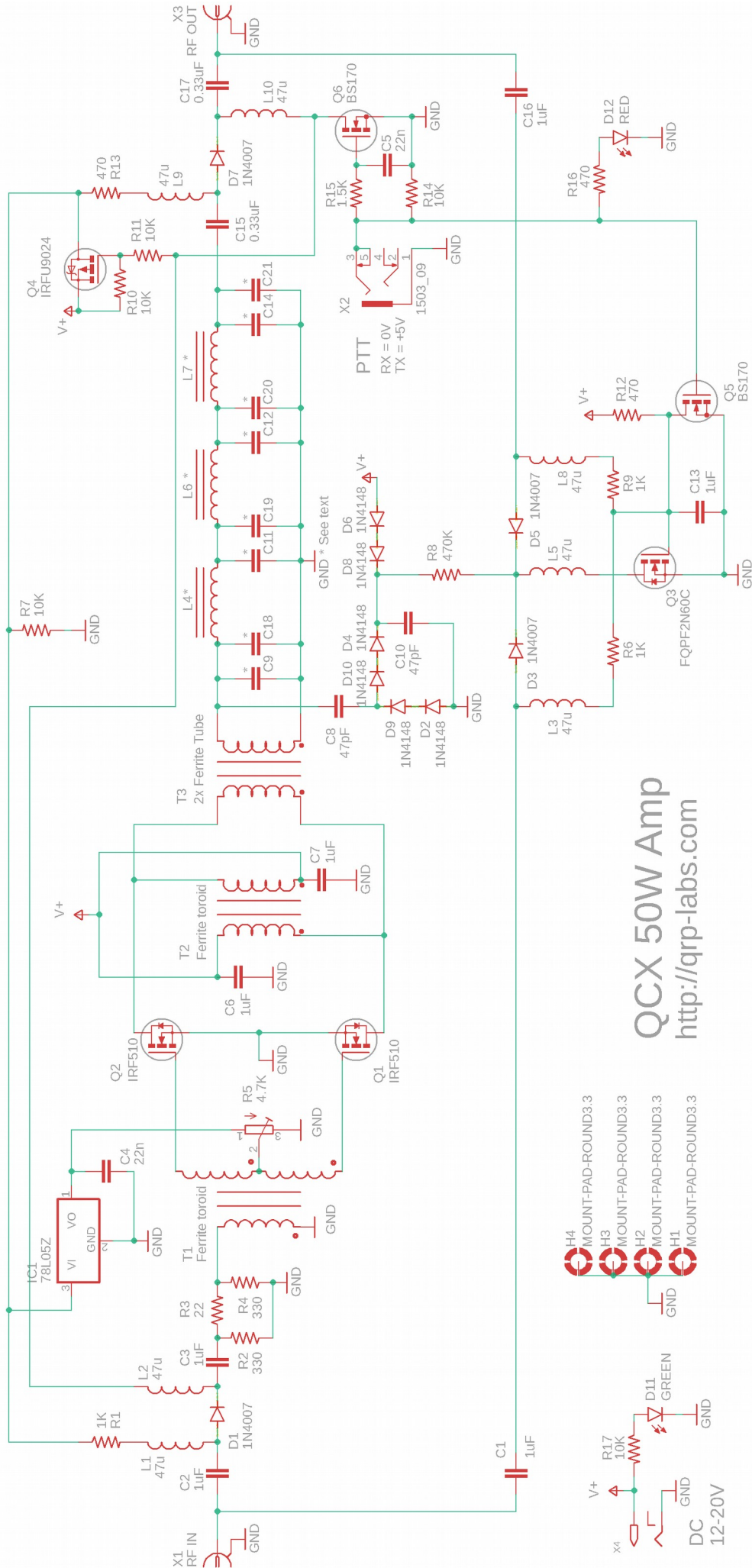

QCX 50W Amp
<http://qrp-labs.com>

- H4 MOUNT-PAD-ROUND3.3
- H3 MOUNT-PAD-ROUND3.3
- H2 MOUNT-PAD-ROUND3.3
- H1 MOUNT-PAD-ROUND3.3

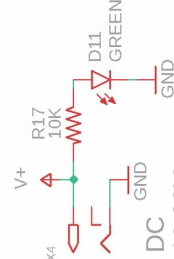

6.2 Input attenuator

The pi-network consisting of R2, R3 and R4 forms an attenuator. This is necessary because the output of the QCX will be approximately 5W into 50-ohms; this is a sinewave with 45V peak-peak. This will be too high for the Gate-Source voltage specification (+/- 20V) of the IRF510 transistors.

To operate the transistor gates safely, and to correctly load the QCX at approximately 50-ohms output impedance, and to ensure stability, this “3dB pad” is a good practice inclusion in the circuit.

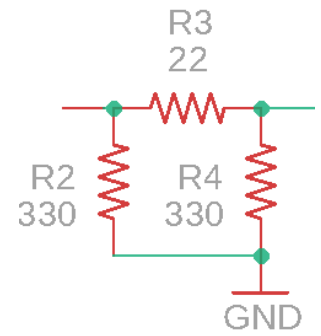

6.3 Power Amplifier

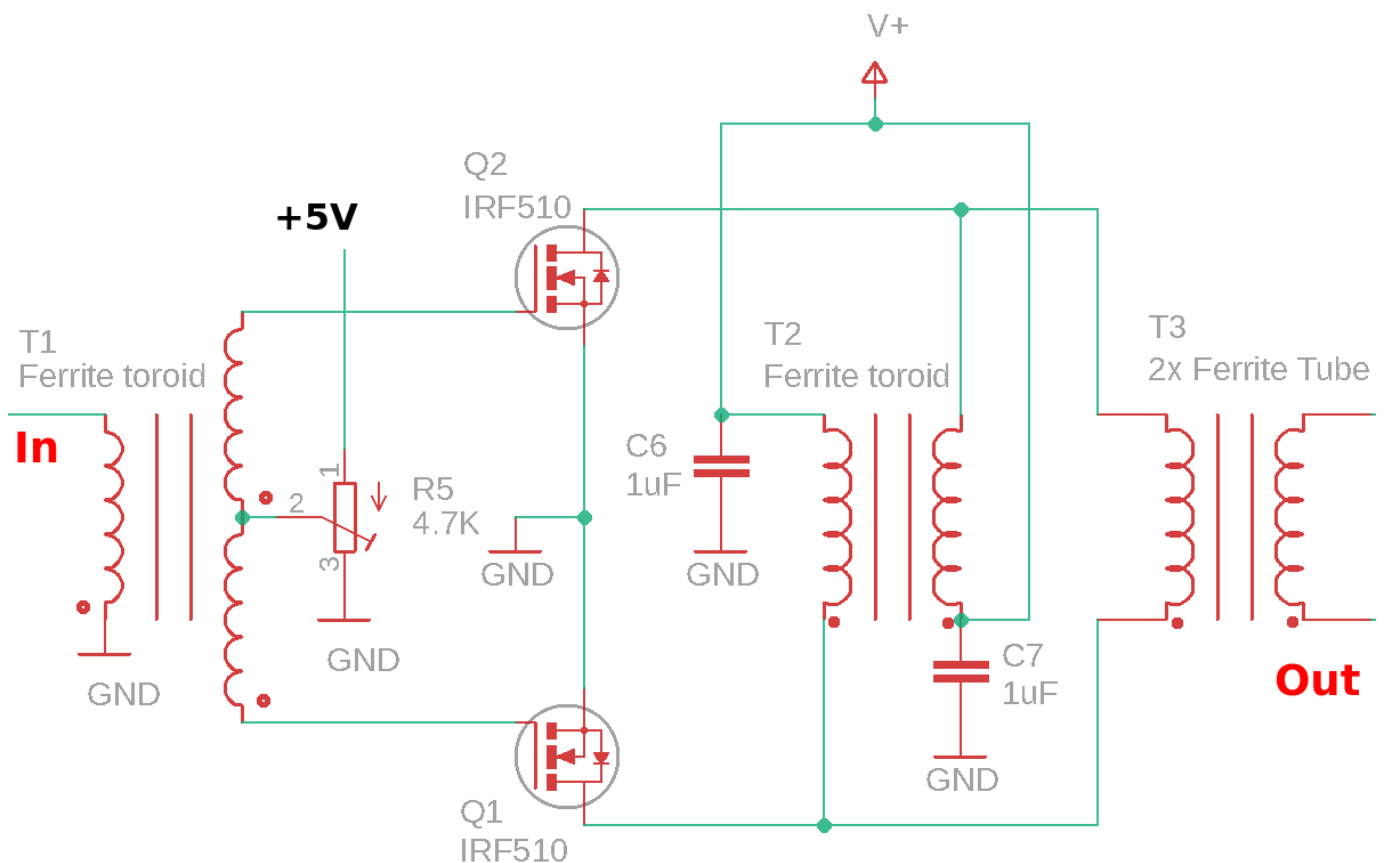

The power amplifier is a quite standard push-pull circuit consisting of two IRF510 power MOSFETs in push-pull configuration.

DC power is supplied to the transistor drains via transformer T2 which is bifilar wound on a ferrite toroid.

The RF output is taken via power combiner and impedance matching transformer T3, which is wound on a pair of large ferrite tubes. The choice of turns ratio is an important design parameter and will be discussed a little later in this section.

Input transformer T1 is trifilar-wound on a ferrite toroid. Its purpose is to split the incoming signal into two equal and opposite parts. Each of the power transistors Q1 and Q2 will be active (switched ON) in opposite halves of the RF cycle. These two outputs drive the MOSFET gates directly.

The gate bias voltage is provided by trimmer potentiometer R5, which is supplied by a 5V 78L05 voltage regulator (TO92 package) IC1, not shown in this schematic fragment. The bias voltage is supplied only during transmit (via P-channel MOSFET Q4, which is ON during transmit only).

A much more frequently seen bias arrangement has two separate trimmer potentiometers, to adjust the bias voltage to each transistor individually. The theory behind this is that the transistor's Gate-Source Threshold Voltage varies from device to device, so needs to be set individually per device. The Vishay IRF510 datasheet for example, specifies V_{GS} minimum 2.0V, maximum 4.0V. Quite a wide range.

It is instructive to compare this schematic to the schematic of the PA section for the QRP Labs 10W Linear kit <http://qrp-labs.com/linear> (that amplifier is designed for 160m to 10m operation) and discuss the differences in gate bias arrangements.

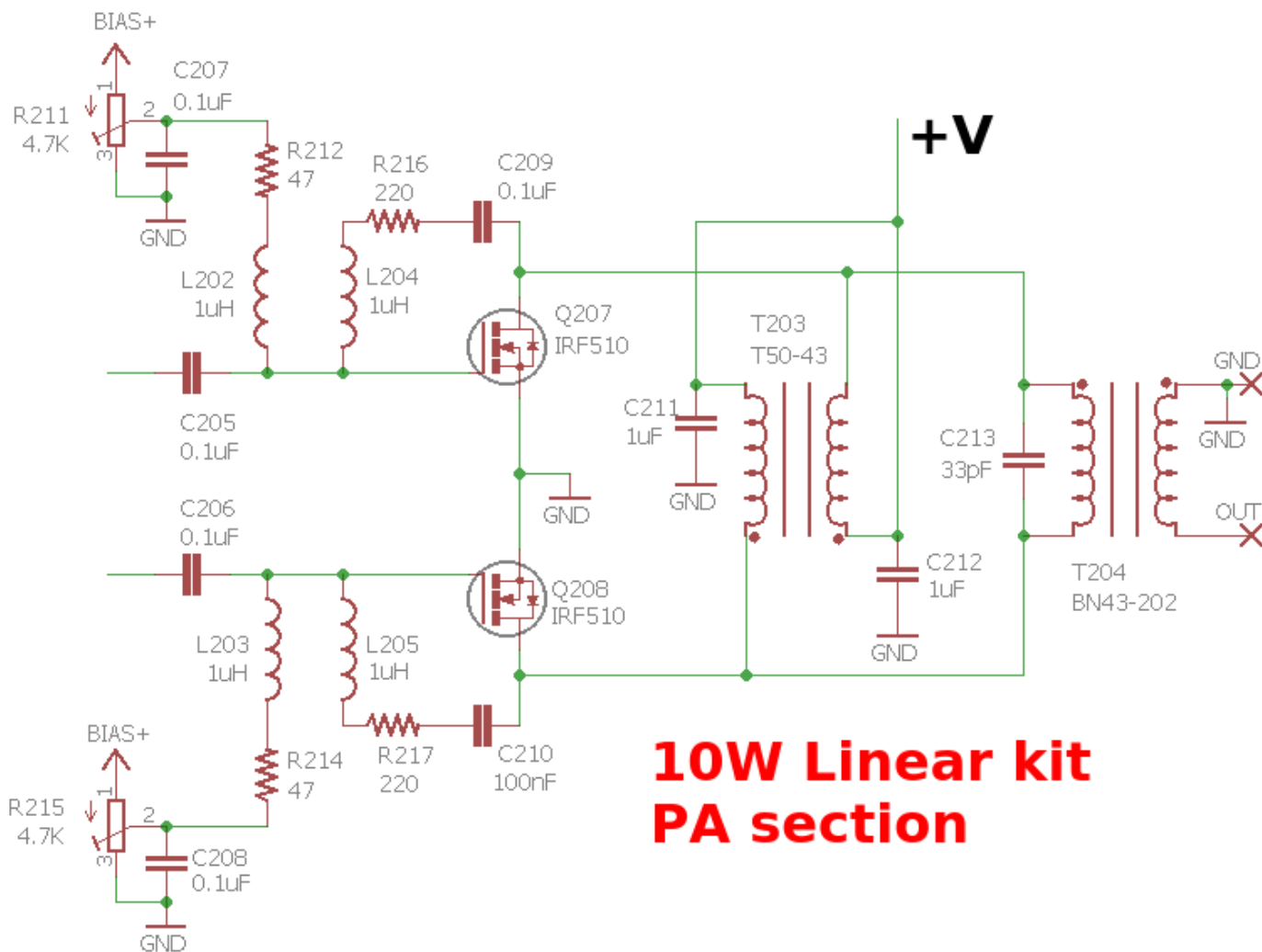

The same DC power method is used (here bifilar transformer T203) and the same output combiner/impedance matching transformer T204.

Note the negative feedback network between the transistor drains and gates (for example, in the case of Q207, the series inductor-resistor-capacitor consisting of L204, R216 and C209). This helps to provide stability at all operating frequencies, improves linearity and also flattens the gain across a wide frequency range (this amplifier is designed for 160m to 10m operation).

In the case of this 50W amplifier (refer back to the schematic), it is intended for single band operation only, and I don't care about linearity (it is a Class-C amplifier for CW), neither do I care about gain flatness across the whole of HF from 2 to 30MHz. The amplifier is intended for 40, 30 or 20m operation and I just want as much power output as possible! So the feedback components are deleted; naturally this also saves cost and board space.

Next consider the bias adjustment circuits. There are two identical circuits, each one consists of a trimmer potentiometer powered by “BIAS+” which is a 5V regulator. There is a 0.1uF decoupling capacitor at the wiper; then a 47-ohm resistor and 1uH inductor in series to the transistor gate. Additionally the gate drive must be AC coupled to the phase splitting transformer by a DC-blocking 0.1uF capacitor. That’s 10 components in total (5 per transistor)!

As the 50W amplifier circuit development progressed and evolved, I found I was able to eliminate 9 of those 10 components! This is achieved by simply connecting the phase splitter transformer T1 output windings directly to the transistor gates, with no DC-blocking capacitor. Instead, the center-tap of this input transformer is connected to the wiper of a single bias adjustment trimmer potentiometer, R5. The inductance of the input transformer T1 windings replace the need for the series 47-ohm and 1uH inductors. The DC bias voltage is supplied to the gates through this input transformer.

A single trimmer potentiometer works because I don’t care much about linearity. I am assuming that IRF510 transistors from the same batch will have approximately similar characteristics. I am not going to adjust them for a precise bias current of 125mA each for linear operation. I’m going to adjust them just for Class-C operation. Everything is a lot less critical! It turns out to be “good enough” to make the single adjustment.

For whatever reason, omitting the decoupling at the trimmer potentiometer wiper was found to slightly increase output power and efficiency. I’m not really sure why that is. But repeated experiments showed it IS the case, and as it is another simplification, why not!

Reducing the number of components in this part of the circuit from 10 to 1 considerably lowers the production cost and simplifies the board layout and assembly.

Here are some comparative measurements I made, of efficiency and power output vs supply voltage. The test cases were:

- Two bias trimmer potentiometers, with no inductors in series to the gate
- Two bias trimmer potentiometers, with 47uH inductors in series to the gate
- Single bias trimmer potentiometer at the input transformer center-tap
- Single bias trimmer a the center-tap with 0.1uF capacitor at its wiper

Note that these are not final power out or efficiency figures, which changed again slightly due to changes elsewhere in the circuit; they are just concentrating on a comparison of bias methods.

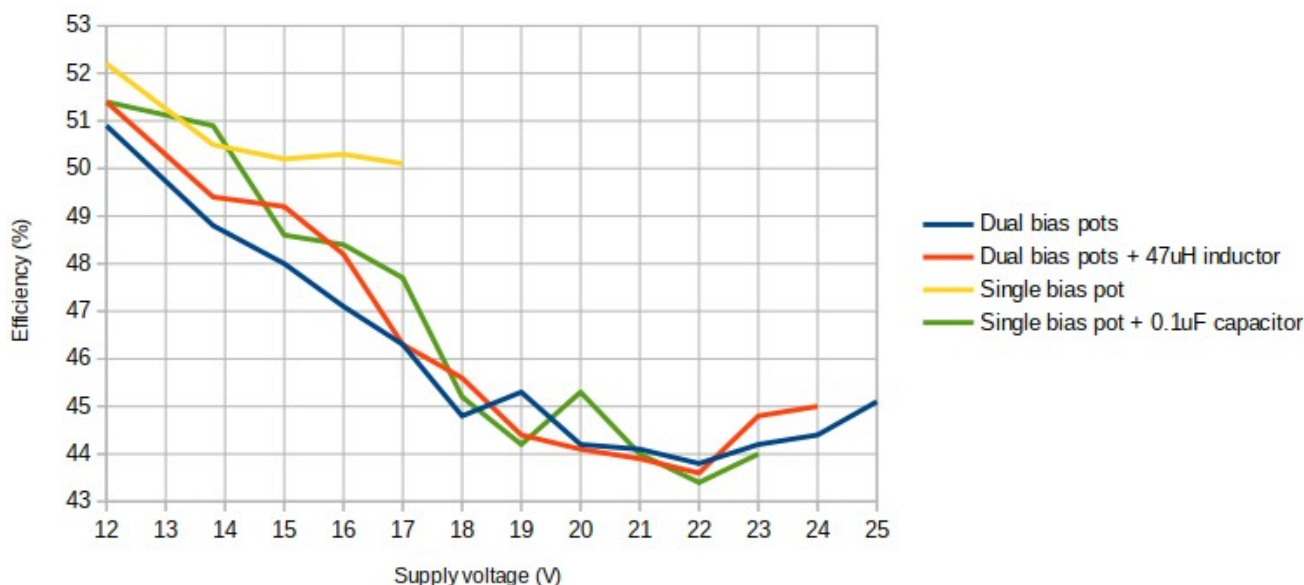

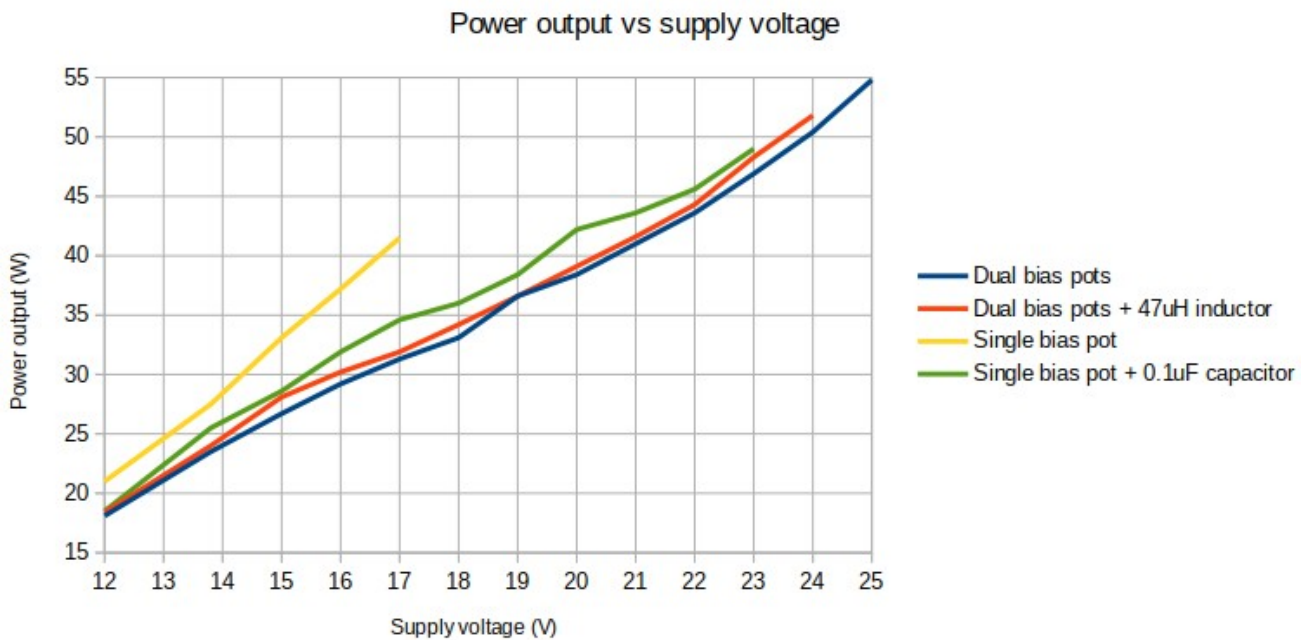

The presence or absence of the series inductor from potentiometer wiper to the transistor gates didn't seem to make much difference one way or the other. Some benefit was provided by using the single trimmer potentiometer bias feeding method but there was a really significant improvement in NOT having the 0.1uF decoupling capacitor at the trimmer wiper! It made a significant improvement in both efficiency and in power output.

Now turning to the output transformer. This is wound on two ferrite tubes with 2:3 ratio (2 turns primary, 3 turns secondary). They provide an easy and convenient method to get enough iron in there at low cost. They don't need to be glued or taped together but it helps keep things neat and tidy.

There were two questions to answer here. Firstly, what turns ratio to use. Secondly, what material and core topology to use.

The turns ratio determines the impedance transformation. The impedance ratio is the square of the turns ratio. We assume a 50-ohm output (enforced by the 50-ohm dummy load used during testing). Tested ratios were 1:2, 2:3, 1:3, 2:4. The corresponding impedances are listed in this table:

Type	Impedance ratio	Primary impedance
1:2	4	12.5 ohms
2:3	2.25	22.2 ohms
1:3	9	5.6 ohms
2:4	4	12.5 ohms

The optimum impedance match depends on desired supply voltage and also the transistors themselves. It is possible to increase the power output for a given supply voltage, by using a higher impedance ratio. But the penalty of this is that the transistor must handle a correspondingly larger current. The power supply must be able to cope with this higher current too.

With reference to the Vishay datasheet, the rated continuous drain current of the IRF510 is 5.6A at 25C, de-rated to 4.0A at 100C. The pulsed drain current is 20A at a "pulse width limited by

maximum junction temperature”. Since the drain current in this application is NOT in fact continuous (it is an RF cycle, and each transistor conducts for half the RF cycle), one might argue that the permissible rating is higher than 5.6A (25C) / 4.0A (100C). In any event, we can see that higher current will eventually kill the transistor so increasing the impedance ratio has limitations.

Furthermore, the higher current will also cause a higher magnetic flux density in the ferrite transformer core. As the core approaches saturation it will become lossy, increasing its temperature, and this will lower efficiency (and power output). In the end it would be necessary to increase the physical amount of iron in the core.

The conclusion is that at higher impedance ratios, we can obtain more output power for a given supply voltage; but the penalty is higher current which places more strain on the transistors and the ferrite of the output transformer.

The question of materials to use is an important one from a kit production standpoint. A driving factor is cost. Availability is another. A beautiful binocular core typically used is the BN43-202 made by Amidon or an equivalent by Fair-rite. But these are expensive, and they must be shipped from US and imported. They are also rather small so the choice is to stack multiple binocular cores together, or to buy larger more expensive cores. It would be much more cost-effective to be able to use locally available unbranded ferrite, which is lower cost and doesn't carry the shipping and import costs. But ONLY if the local ferrite provides equivalent performance! Therefore ideally we want low cost ferrite, only IF it works well enough, and in the smallest possible size, available locally. The binocular format is convenient and efficient, and is usually used in power amplifiers.

I undertook a large number of tests of various materials and turns ratios, some of the more useful ones are plotted in the following graphs. Materials tested:

- Large unbranded ferrite toroid
- Large unbranded ferrite binocular core
- Amidon BN43-202 ferrite binocular core, four stacked together, or two stacked together; the size of the four stacked together was similar to the size of the large unbranded core or the 2 unbranded ferrite tubes side-by-side.
- Two unbranded ferrite tubes laid side-by-side

Power output vs supply voltage, different cores and winding ratios

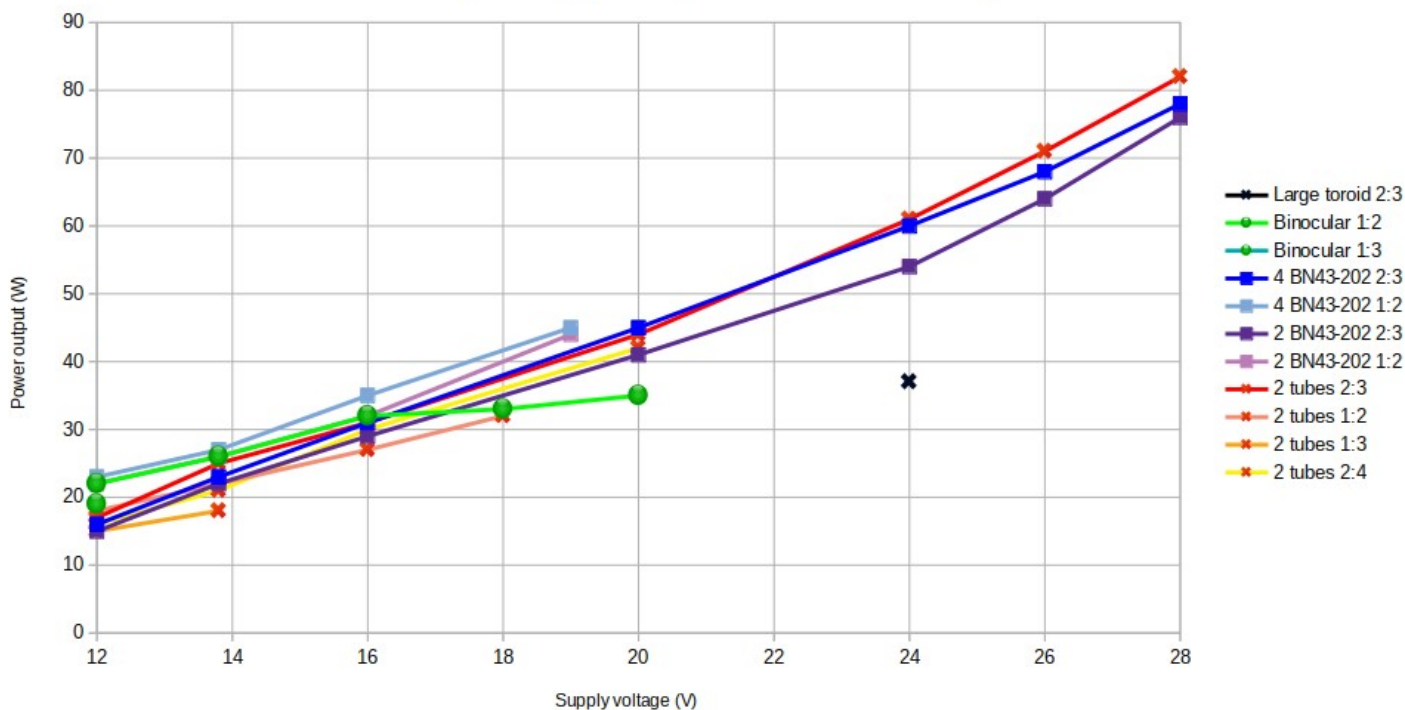

Efficiency vs supply voltage, different cores and winding ratios

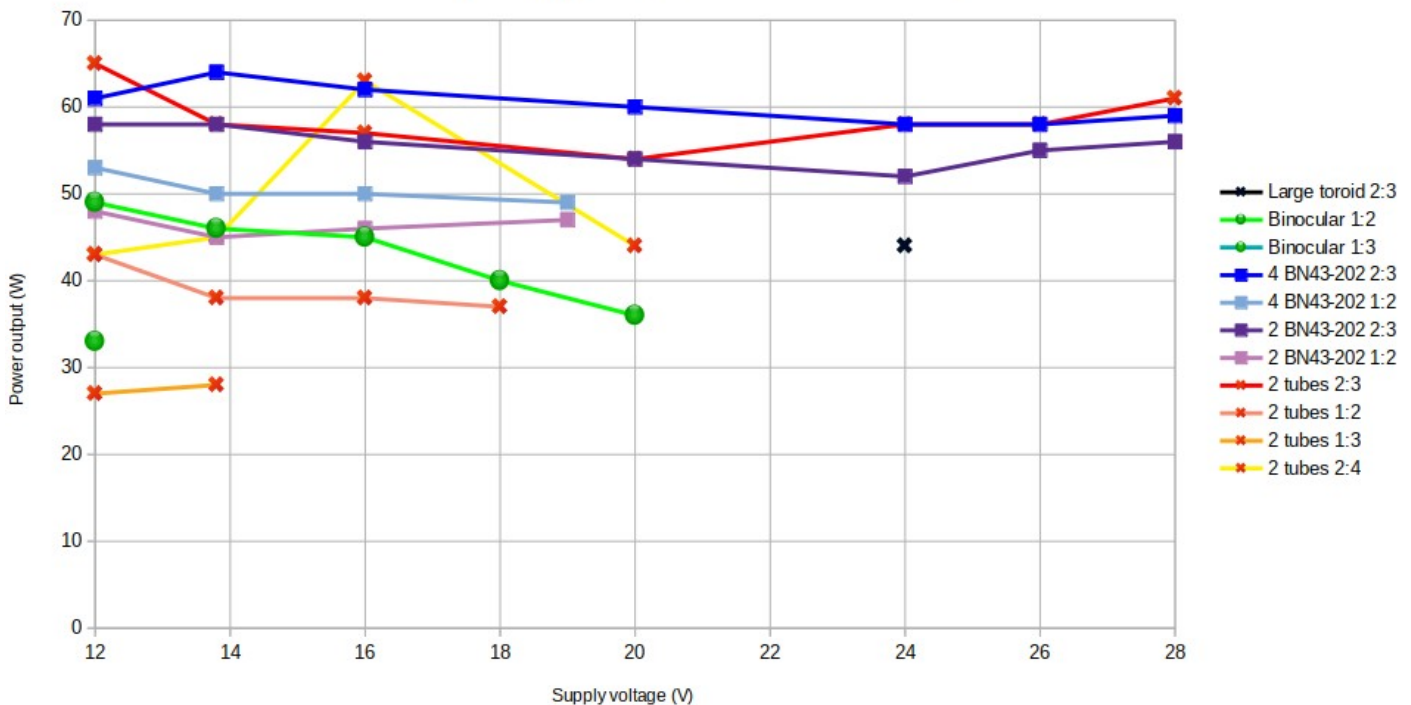

DC was power supplied by a variable regulated 0-30V 5A bench power supply. A QRP Labs 50-ohm dummy load kit was used as the load (drastically overloaded, but only for very short periods, enough to make the measurement). Power measurements are made by observation of the peak-peak voltage on an oscilloscope. Efficiency calculations are power output / DC power input; where DC power input is the product of the current and voltage displayed on the power supply.

Note that the higher turns ratio measurements had to stop at lower voltages (e.g. 20V), I could not get the power amplifier up to the chosen 28V top of my measurement range; this is because the higher turns ratio output transformers have much lower efficiency and larger current draw, and caused the power supply current limiting to kick in. (The current limit evidently occurs at around 4.8A not the claimed 5A – though it does occur at 5A for lower voltage settings).

After a lot of staring and consideration at these graphs, I could eventually draw the following conclusions.

1. The stacked Amidon BN42-202 binocular cores did indeed provide higher power output at a given supply voltage with higher impedance ratio. However there was a high penalty (10-15%) in the efficiency calculation.
2. The higher turns ratio did not apparently provide any power output benefit with the other ferrite cores tested, and showed an even worse efficiency penalty.
3. 1:3 ratio was even worse than 1:2 ratio!
4. The 2:4 turns tested on the 2-ferrite-tubes produced better results than 1:2 turns, even though the ratio is the same; I speculate that the larger amount of wire inside somehow provides better coupling.
5. When two BN43-202 toroids were stacked end-to-end, instead of using four stacked BN43-202, there was a noticeable deterioration in both power output and efficiency. I believe two BN43-202 simply doesn't provide enough ferrite and is therefore more lossy.
6. The large unbranded toroid did not give good power output nor did it give good efficiency, compared to the binocular format ferrites; additionally it was very hard to wind the thick diameter wire, on a toroid form. Therefore no further testing was done with this toroid.

7. The binocular core formed from two unbranded ferrite tubes actually gave slightly higher power output than the four BN43-202 stacked cores, and this higher power output was even more noticeable above 50W. Efficiency of the tests using the unbranded ferrite tubes was slightly worse than the four BN43-202 stacked cores at lower power levels, but was better at higher power levels.

This final conclusion is the most surprising. Basically, it is not necessary to use expensive Amidon ferrite and ship it around the world. The results with locally available unbranded ferrite are just as good, and at 10-20x lower price! A very pleasing result indeed.

These conclusions led to the final design of T3 which uses the two side-by-side unbranded ferrite tubes to create a binocular core, and the 2:3 turns ratio which is apparently definitely optimum for IRF510-based power amplifiers in this application.

Further reading on the power amplifier section of the design:

- My starting experiments on a single-ended 35W IRF510 40m CW PA and then a 50W IRF510 push-pull successor are documented here: <http://qrp-labs.com/qcx/qro>
- Mike WA2EBY's two articles in QST's March and April 1999 issues are very instructive. Mike builds a broadband HF amplifier stating "with only 1W of drive, you'll get over 40W out – from 160 through 10 meters!". He uses two IRF510 transistors with 2:3 turns output transformer, a very similar arrangement to the QRP Labs 50W amplifier. See <http://qrp-labs.com/qcx/qro> and scroll to the bottom of the page.

The similarity of Mike's design and the fact he is aiming for linear operation, could inspire you to try this 50W amplifier as a linear. Mike does not present any linearity measurement (two tone IMD3 for example). But I feel a lot of further experiment would be possible with this amplifier, for linear applications.

6.4 Thermal considerations

Before going any further, and on the topic of the main PA section, the heart of this project – it is necessary to discuss HEAT.

Heat is my old enemy, for as long as I can remember. No less so on a POWER AMPLIFIER!

A problem with the IRF510 is the relatively high thermal resistance of the junction-to-case, specified as 3.5 C/W. This means that for every watt of dissipated heat, the junction temperature relative to the case will rise by 3.5 C.

Additionally the datasheet quotes a case-to-sink value for a flat greased surface, of a minimum of 0.5 C/W and a maximum junction-to-ambient thermal resistance of 62 C/W. The latter assumes no heatsinking which is clearly not relevant here unless our hobby is rapid explosions of inexpensive MOSFETs.

Furthermore the operating junction temperature range is specified as -55C to +175C absolute maximum rating. Practically we should try to stay substantially below 175C to assure long-term reliability of the transistors. The failure rate of most silicon semiconductors decreases approximately by half, for a reduction in junction temperature from 160C to 135C. Military standards are that junction temperature does not exceed 110C. (Source: ON Semiconductor, App note AN1040-D).

So now let's calculate. Suppose we are producing 50W, at an efficiency of 50% (to keep it round numbers). That means for every 50W of RF we produce, we are also producing 50W of unwanted

heat in the IRF510s which has to be dissipated otherwise they will overheat and die fast. That means 25W per device (this assumes equal power distribution between the two devices; in reality there will be variations of characteristics between them so the situation will be worse than this for one of them, and better than this for the other). The thermal resistance to the heatsink is $3.5 + 0.5 = 4.0$ C/W. Therefore at 25W dissipation, the temperature differential between the device junction and the heatsink is $4 \times 25 = 100$ C.

We have not taken into account that there will be an additional resistance caused by the silicone electrically insulating heatsink pad that must sit between each IRF510 metal tab, and the heatsink. Figures vary but these silicone insulators are better than I'd have estimated. Depending on whose numbers you believe. Let's assume 0.5 C/W which is around what is normally quoted. So now the temperature differential to the heatsink is 4.5 C/W \times 25 W = 112.5 C.

But the heatsink is itself not at room temperature. It is hotter than the surroundings. It is radiating heat to the air as best it can, but it too has a thermal resistance in C/W which causes its temperature to rise, of course. During more than 500 QSOs testing during summer 2019, I had a digital thermometer probe jammed between the heatsink fins and was watching it nervously throughout all my QSOs. In all cases, I was using the actual heatsinks provided with this kit.

Most stressful for the PA turned out to be CQ'ing for long periods of time. In practice, CQ'ing with 50W output power for prolonged periods of time is difficult to achieve, because someone will answer! But if you choose a time when the band is closed or nobody is around, etc., then you can get some testing done. During this time the highest heatsink temperature I recorded was 45 C. Generally it was around 40 C. So, considering an ambient temperature of 20-25 C, we can say roughly a 20 C temperature rise to ambient.

So in this case, at worst 45C, the temperature rise would be 112.5C and that would put the junction temperature at 157.5 which is already much higher than the military spec and getting close to the datasheet "absolute maximum".

The calculation is invalid in so far as it assumes a continuous key-down situation. CW reality is not continuous keydown. In the example quoted (lots of CQ) I transmit CQ, which has a duty cycle a bit above 50%, then wait 10 seconds for a reply, then repeat. So say, a 50% duty cycle. The 45C maximum temperature recorded is therefore for a 50% duty cycle transmission.

If the duty cycle was 100% then the heatsink temperature would be double the differential to the ambient temperature, say 65C. Then the junction temperature would be $65\text{C} + 112.5\text{C} = 177.5\text{C}$ which is beyond spec and the IRF510s would not last long. There will be one bang as one transistor expires (the one doing the most work) followed not long after by a second bang as the second one expires.

At a duty cycle of 50% the actual junction-to-heatsink temperature differential will be half the calculated 112.5C i.e. 56.25C; the junction temperature is therefore $56.25 + 45\text{C} = 101.25\text{C}$. The real situation will be even better than this because in an actual QSO, you will spend approximately half your time listening to the other guy, then the other half talking to the other guy, with a bit over 50% duty cycle while talking; the average will be nearer to 25%.

To summarize:

- In normal use CW with a 50% duty cycle and ordinary overs, the junction temperature of both IRF510s will be below 100C, which meets "military spec" and everything will be fine. This is confirmed by my 500+ QSOs, where I had no transistor failures at all all summer 2019.
- In a continuous key-down situation, junction temperature will soon exceed safe limits for the transistors and they are likely to go off with a bang

The moral of the story is therefore: operate CW normally. Do not sit on the key for long periods, which will probably blow up the transistors. A bit of tuning up or testing for a few seconds is fine. Just don't overdo it. Be kind to the transistors. If you don't believe me, by all means try it. At least IRF510s are low cost, which is a great benefit of this kit!

6.5 Low Pass Filter

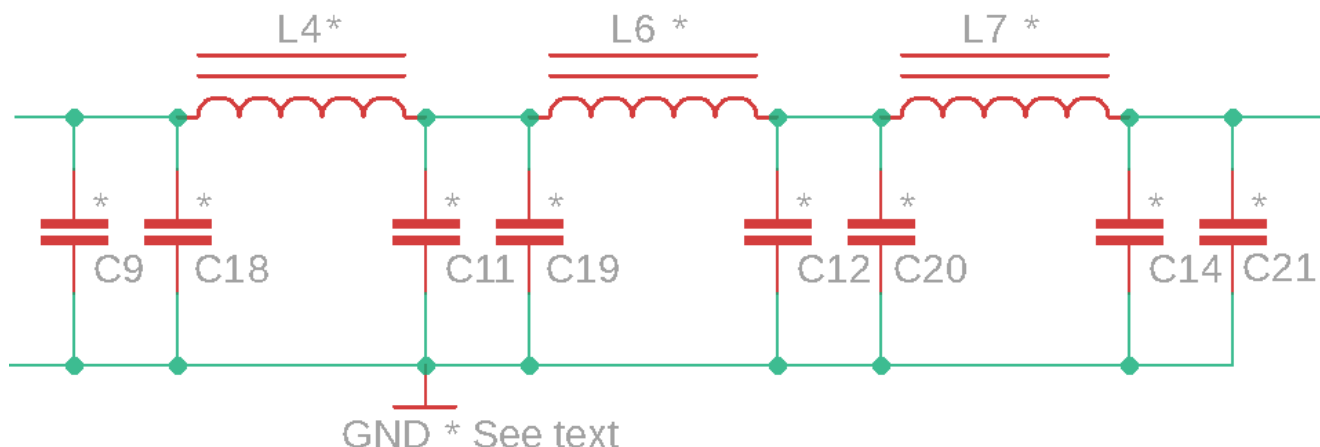

A Low Pass Filter (LPF) is always required, following any amplifier (even a linear!) to attenuate harmonics caused by non-linearities. Yes, even a linear amplifier has non-linearities! Though they are smaller, so you often see less aggressive filtering. Here, our PA is operated in Class-C, which is not linear. Therefore we use a 7-element Low Pass Filter design which is well tried and tested, and is the same design as used in the QCX transceiver itself, and in the QRP Labs LPF kit <http://qrp-labs.com/lpokit>.

There are two important differences, both are related to power handling. Here, the amplifier produces over 50W. That requires:

- Powdered iron toroids which have enough iron in them that they will not saturate and become lossy, at 50W
- NP0/C0G capacitors which have a high enough voltage rating to withstand the peak voltage excursions seen at 50W.

50W is a 141 V peak-peak sinewave. In the Low Pass Filter the sinewave is referenced to ground so what matters, in theory, is the peak sinewave relative to ground – which is 70.7V. However, in the case of a mismatched load (higher than perfect 1.0 SWR) the voltage is higher. In the original QCX kit the LPF capacitors are 50V rated, it is fine for QRP but not here. So in this kit, 250V ceramic NP0 capacitors are provided.

The reason for using NP0 (near zero temperature coefficient) capacitors is not that we care at all about the very slight capacitance change with temperature which would occur with a non-NP0 capacitor; but because the same ceramic dielectric which gives the near-zero temperature coefficient also gives very low loss at RF. Non-NP0 capacitors are rather lossy at RF. The capacitors are also known as Class-I dielectrics (as opposed to “normal” non-NP0 Class-II dielectric capacitors).

The toroid size question is solved with a little internet research, the conclusion of which is that T50-size toroids are plenty sufficient for 50W power handling.

Note that the first versions of my 50W Power Amplifier development used inductors I wound using 1.6mm enameled copper wire on sawn-off 5cm (2-inch) sections of broom handle.

The first prototype PCB, I thought it would be neat, and interesting, and rather unusual and different, to remind ourselves of how the old-timers used to wind coils. Real coils! Before toroids became so popular. So I developed a neat PCB in which the coil was wound through holes on the PCB. Pieces of an additional PCB design were broken off and soldered perpendicularly to the PCB so that the coil benefited from support at 4 points in the circle.

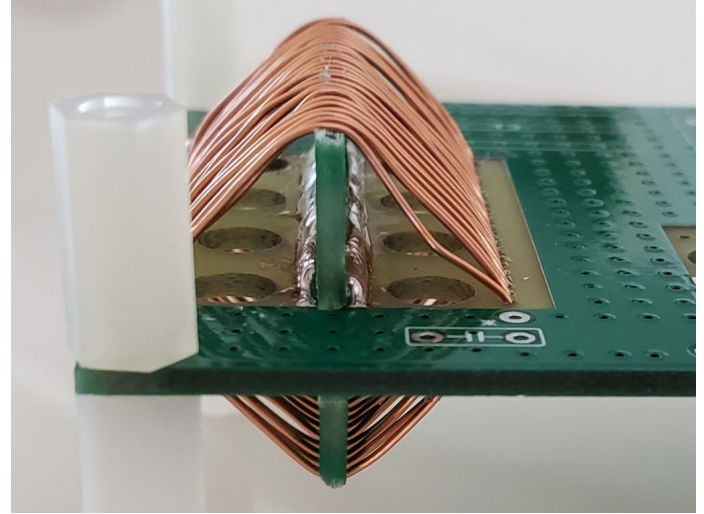
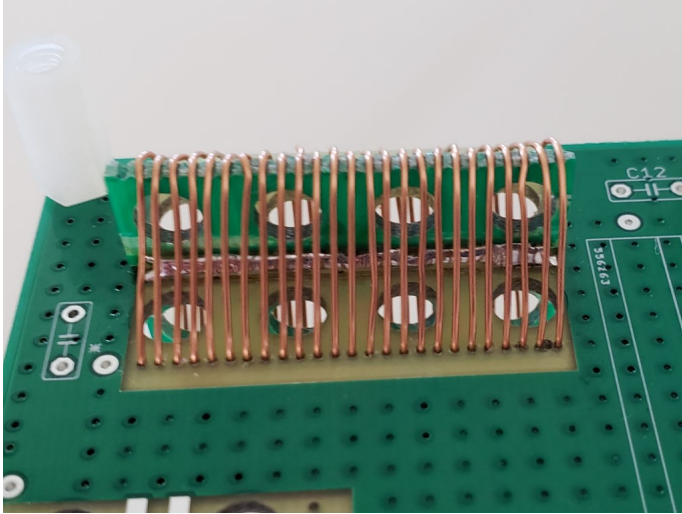

These coils are beautiful, easy to wind, and with a highly repeatable and stable inductance. HOWEVER, with measurements I discovered that they result in a relatively poor performance compared to inductors wound on T50-6 toroids. The toroidal topology has inherent self-shielding properties which prevents the field of one coil interacting with the field of another. I had spaced the air-cored inductors as widely as I could, but PCB area is a limitation. So I suspect that the air-core inductors, containing more wire (and hence higher resistance) may be a lower-Q than the toroidal ones, and may also interact with each other, resulting in signal leakage. The result was slightly lossy LPFs which resulted in several watts lower output power.

So that experiment was abandoned and the final design went ahead with T50-6 toroids.

The final PCB has two capacitors paralleled at each position. The reason with this is that it allows me to supply sufficient capacitors to build the kit either for 40, 30 or 20m, with least waste – since some values can be made from the combination of others. Additionally for people wishing to experiment with other bands, it provides you the opportunity to make up the required capacitance value but the addition of two smaller capacitors if you need to.

6.6 Transmit / Receive switching

We now come to by far the most complex part of the design, the transmit / receive switching arrangements. Many simple low cost projects use relay switching. The problems with relay switching are many:

- Bulky
- Noisy
- Slow – too slow to allow fast switching for full break-in (QSK) operation
- Expensive
- Unreliable (mechanical moving parts)
- Poor isolation at RF, can be important in some applications (unless expensive relays used)

Of critical importance out of these disadvantages, was the cost, and the speed of operation. A key design criteria for me was to be able to switch back and forth between transmit and receive in a very short time, so as to allow full break-in operation (QSK) where the other station is audible between the transmission of your own CW dits and dahs. That is not possible with inexpensive relays, which would be too slow, too noisy (clickety clack) and would wear out quickly.

The solution comes in the form of diode switching. Not just any old diode, PIN diodes. This is a fascinating topic and I did a great deal of research and experiment to perfect the circuit.

This is essentially the switching requirement:

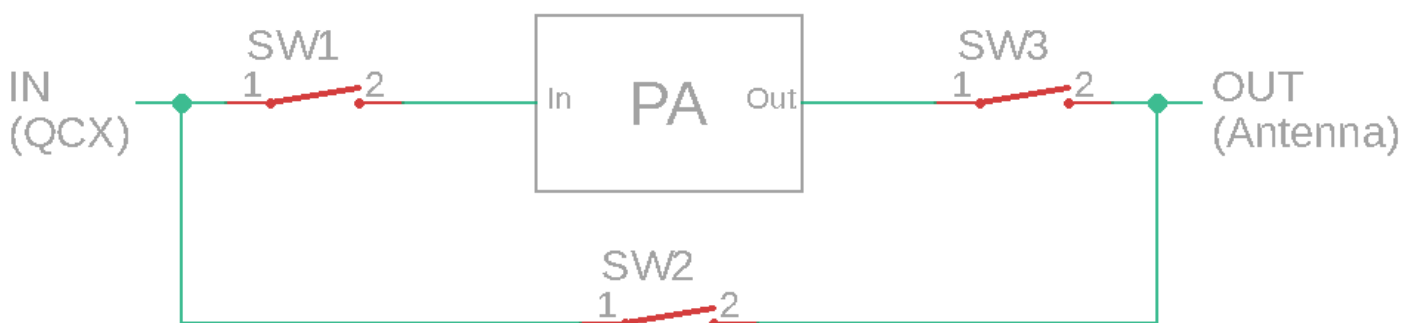

The block labeled “PA” encompasses the Input attenuator, actual PA circuit, and Low Pass Filter discussed earlier.

During transmit, SW2 should be open (Off), with SW1 and SW3 closed (On), such that 5W power output from the QCX reaches the input of the PA through SW1. 50W power from the PA output passes through SW3 to the antenna. At the same time SW2 should be open (Off). Crucially, the Off isolation of SW2 must be somewhat more than the gain of the PA under all foreseeable circumstances (including at all frequencies of interest, and during transients at key=down/key-up). If it is not, then a positive feedback situation will exist and power will travel around the loop from output to input, in a self-sustaining spurious oscillation, that is at the very least undesirable and at the worst could cause damage to the PA.

During receive, SW1 and SW3 should be open (Off) so that the PA is isolated from the circuit; and SW2 should be closed to allow the antenna to be connected to the Receiver input (QCX antenna port).

Ideally the insertion losses through the switches should be very low. And when they are Off, the isolation should be very high. It turns out as I mentioned above, that isolation loss of SW2 is very important so as to prevent positive feedback leading to spurious oscillations; furthermore low insertion loss, particularly in SW3, is very important otherwise some of the 50W power which we have worked so hard for, will be reduced. You can talk about what a small difference, in dB terms or S-point terms, losing 5W out of 50W makes, all you like... fact is, when you see that loss on a ‘scope, it bites. Irritating, to say the least.

For switches, we use PIN diodes. These have been used in transceiver designs for ages and ages. Ordinary diodes cannot be used for switching because they could act as Rectifiers, switching on and off in time with the RF cycle.

A PIN diode, however, is different. It is a diode with a wide undoped “intrinsic semiconductor” region between the usual P-type and N-type doped semiconductor layers of a regular diode (Wikipedia image).



The important point is that this undoped “intrinsic layer” acts like a storage reservoir. When incoming forward-biased current arrives, this “intrinsic layer” fills up with electrons. When the diode is reverse biased, it takes time for all these electrons to empty out of the intrinsic layer. At high enough frequencies, the time available is too short! So the diode never “turns off”. It remains conducting through the whole RF cycle.

PIN diodes behave like variable resistances. Their resistance is determined by the amount of DC forward bias current. They are near-perfect variable resistors which add very little distortion to the signal. In our case, we don't care about variable resistors, all we want is either a very low resistance (On), or a very high resistance (Off).

A problem is that PIN diodes tend to be expensive, harder to find items. However, a solution comes along, the 1N4007 rectifier diode! This is the big brother of the 1N400x series of rectifier diodes, and has a reverse voltage rating of 1,000 V. By good fortune, its internal construction in order to achieve this very high PIV rating, is very similar to a “real” PIN diode. Hence the 1N4007 is often referred to as the “Poor man's PIN diode”!



No doubt the 1N4007's characteristics are not repeatable enough, or its resistance not linearly controllable enough, or some such other imperfection, that it is not suitable for all applications. But in our application where all we need is an On/Off switch at HF, a 1N4007 costing mere cents functions just as well as a “real” PIN diode costing 50x the price!

1N4007 functions well enough as a PIN diode switch across the whole of HF to 10m band, and even down to 500kHz.

What about dynamic range and third order intercept point IP3? A properly handled 1N4007 should not impact the dynamic range or IP3. An excellent set of measurements by Claudio IN3OTD see https://www.qsl.net/in3otd/electronics/PIN_diodes/PIN_diodes.html and https://www.qsl.net/in3otd/electronics/PIN_diodes/1N4007.html confirms the excellent characteristics of the 1N4007, which at HF in this switching application are similar to other PIN diodes. Other experimenters have determined similar results. Broad conclusions are that a properly biased 1N4007 at HF (1.8MHz-3MHz) has the following characteristics:

- “On” insertion loss less than 0.1dB for 10mA forward bias current
- “Off” isolation at least 30dB (at worst case, 30MHz frequency)
- IP3 > +50dBm

Therefore the use of 1N4007 PIN diode switches should result in very little loss of transmitter output power, very little loss of sensitivity on receive, and will not degrade the excellent IP3 (and dynamic range) characteristics of the QCX transceiver.

What of “proper biasing of PIN diodes”?

In my opinion the most excellent reference for the use of PIN diode switches for HF Transmit/Receive is the work of Don W6JL. Don has a very informative page on QRZ.com <https://www.qrz.com/lookup/w6jl> and a long article “Homebrew PIN diode QRO QSK system” in Funkamateer, March 2016 which is available as a PDF on the internet see https://www.funkamateer.de/tl_files/downloads/hefte/2017/w6jl_improved_qsk_system_mar_2016.pdf. Study of W6JL's work should be the first task of anyone wishing to experiment with HF PIN diode switching. Don has a separate homebrew transmitter and receiver. The transmitter is 600W and is permanently connected to the antenna and the receiver, via his solid state PIN diode switching system. Sidetone is via the receiver monitoring the transmitter directly! The switch

provides 137dB of isolation in the “Off” state. Amazing! We don’t need anything so extreme (or complex) here – but the principles are well described by W6JL and his work is inspiring.

It is possible to distill the whole topic into two important rules:

- To switch the PIN diode Off, apply a large reverse bias VOLTAGE. The voltage should be higher than the peak-to-peak RF being switched.
- To switch the PIN diode On, apply a forward bias CURRENT; the more current, the lower the insertion loss. At 10 mA forward bias, the insertion loss is only about 0.1dB. One can increase it a bit further, to be on the safe side.

During the research phase of this project I studied in detail, the schematics of around 10 commercially available HF amateur radio transceivers that use PIN diode transmit/receive switching. These are designs by some big, well-respected name manufacturers (who shall here, remain nameless).

I was absolutely astonished to find that NONE of these 10, high performance transceivers, actually follow these two guiding principles of PIN diode switching properly. My mouth hung open in shock for quite a while... in ALL of the 10 schematics, I could find problems with the transmit/receive switching. In some, you could see that the designers had found evidence of the problems, and had implemented workarounds to reduce the symptoms, or additional components to minimize the harm. I had also read for years, in my favourite RadCom columnist Pat Hawker G3VA (RIP: now SK) “Technical Topics” column, of some of the problems of PIN diode switched transmit/receive switches – for example, generating huge spurious spikes at the instant of transmit/receive switchover. I myself noted these problems too, but I worked hard on the design to find out the cause and fix it!

When the two “rules” are followed carefully, the performance of the PIN diode switch is excellent; furthermore it is low cost and reliable to implement using inexpensive common components like the 1N4007 and switches in a matter of microseconds so it allows the full break-in (QSK) performance of the QCX to be maintained. It is necessary to use some additional transistors so that a “Key-down” or “Push-To-Talk” (PTT) signal from the QCX transceiver (or other) can cause the necessary biasing of the diodes.

To start with, take for example the switch named “SW1” in my above block diagram. On the 50W PA schematic, this switch is implemented by a 1N4007 diode as shown in this schematic fragment (right).

The signal comes in from the RF input of the amplifier via C2. It passes through the “PIN diode switch” D1, and via C3 to the 3dB pad attenuator, then into the PA input.

The DC-blocking capacitors C2 and C3 are necessary to isolate the DC conditions that we set up to bias D1 correctly, from the RF signal path at the amplifier input and the PA input. At 7MHz a 1uF capacitor has a reactance of 0.023-ohms; for low loss we want this reactance to be small in comparison to the 50-ohm system impedance. 0.023 ohms is suitably small.

The 47uH inductors L1 and L2 are required in order to block the RF from getting into the bias switching circuits, where it could leak around the amplifier and cause positive feedback; and anyway cause unwanted insertion loss by dissipating power where it should not go. At 7MHz, the reactance of a 47uH inductance is over 2 Kohms; this is sufficient in a 50-ohm system to prevent problems.

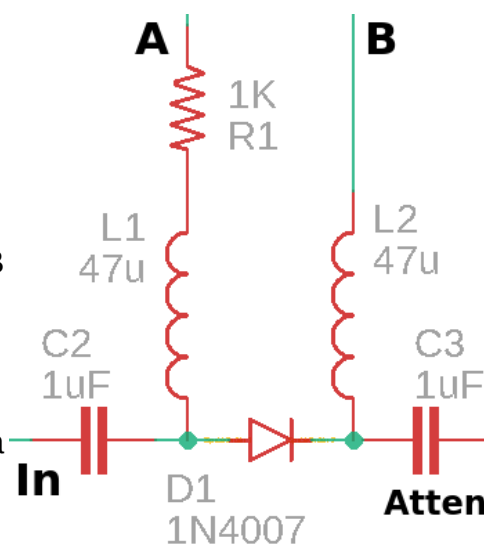

To switch ON the diode D1, we arrange for a forward bias CURRENT to flow through D1. For this, we set A to the supply voltage, and B to ground. The current flows through the diode, limited only by R1. Using Ohm's law ($I = V / R$) with 12V supply voltage leads to a current of $12 / 1000 = 12\text{mA}$ (neglecting voltage drop across the diode and other losses). At 20V supply voltage the current would be 20mA. Recall that with 10mA forward bias, the insertion loss is under 0.1dB. So this "ON" condition is adequate for the switch.

To switch OFF the diode D1, we arrange for a negative bias VOLTAGE to be applied. To get this, we set A to 0V and B to the supply voltage. The 12-20V (supply voltage) reverse bias voltage is enough to cause D1 isolation to be at least 30dB (in the worst case, at 30MHz). Since D1 is Off during Receive, and no large signals are expected, not anywhere near 12V peak-to-peak (which would be an ENORMOUS, receiver front-end-frying signal) – this is plenty adequate for the Off state.

These A and B signals are generated by transistor switching which is shown around the PIN diode switch at the other end of the amplifier, which is SW3 in the block diagram at the start of this section.

This PIN diode switch "SW3" is responsible for switching OFF during Receive, to isolate the PA and LPF output from the Receiver signal path.

Note that it would be possible to just leave the PA connected all the time (eliminating SW1 and SW3) and this is indeed a short-cut that some designs take. However, I wanted to ensure that the antenna was cleanly connected to the Receiver during Receive, properly isolated from the PA sections so that proper 50-ohm antenna matching to the Receiver is maintained. In this way, the excellent Receiver performance of the QCX is not degraded in any way by the presence of the 50W amplifier.

In the diagram (right) you can see the D7 "PIN diode" switch again, just as in the diagram discussed just now. Again we have DC blocking capacitors C15 and C17 which isolate the DC bias conditions from the RF signal path. And again we have 47uH inductors L9 and L10 which keep the RF from leaking into the bias control circuits.

Notice that here the capacitors C15 and C17 need to be high voltage types, because they will handle 50W (141V peak-peak). But high voltage capacitors are expensive, particularly a 1uF capacitor. Initially in my developments I was using an 0.022uF junkbox capacitor for C17. One day, I smelt burned plastic and heard crackling in my headphones. Upon inspection I found C17 was very hot, it was melting internally and liquids were bubbling out. Why? Because that particular capacitor was lossy at RF, effectively dissipating power. Power dissipation in a small capacitor volume can cause significant heating! No wonder it got so hot it started to break down and bubble!

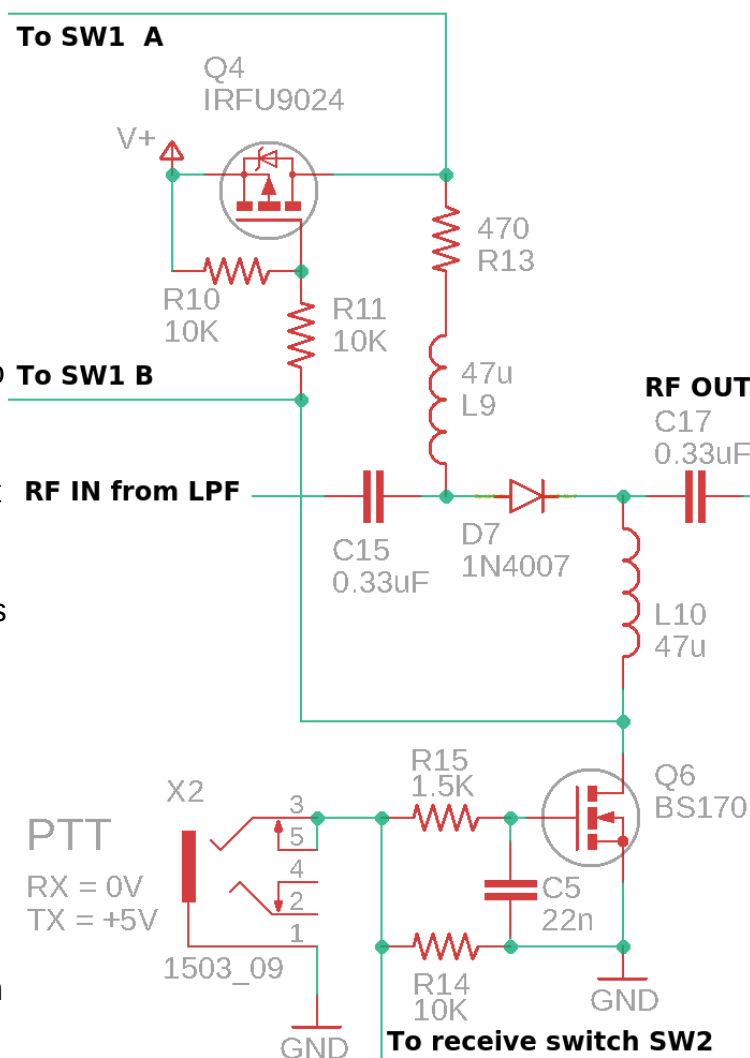

The solution was to change it to 0.33uF and a proper low loss NP0 type with Class-I dielectric, which is a not-too-expensive high voltage capacitor at DigiKey, and has low enough loss not to dissipate power and overheat.

This is the reason why both C15 and C17 are 0.33uF capacitors.

The forward bias current in D7 is determined here by R13 (470-ohms) is 25mA at 12V, rising to 42mA at 20V supply. That's plenty to ensure that to give a very low insertion loss, so minimal power is wasted when the switch is "ON". Again, when the switch is OFF, 12V-20V supply voltage as reverse bias is plenty more than enough, more than any signal we are expecting to receive on the antenna.

The incoming "PTT" signal is designed to switch with 0V for Receive, +5V for transmit.

During Transmit, transistor Q6 gate is 5V, which switches MOSFET Q6 On. That pulls the "B" signal sent to SW1 to 0V; it also pulls the forward bias current through D7. At the same time, this 0V turns on the P-type MOSFET Q4 (IRFU9024), which then passes the supply voltage to the SW1 "A" signal, and also pushes forward bias current through D7 via 470-ohm resistor R13. This creates the proper forward bias current conditions for switches SW1 and SW3 to be ON.

During Receive, transistor Q6 gate is 0V, and this switches MOSFET Q6 Off. P-channel MOSFET Q4 is then also Off, because its gate voltage becomes 12V-20V (supply) via R10. The supply voltage also feeds into the SW1 "B" signal to apply reverse bias to SW1 diode, and also applies reverse bias voltage to D7 via the resistor R11. Meanwhile the SW1 "A" signal and the D7 diode anode are pulled to 0V by resistor R7, which is a 10K resistor to ground – it is not shown in this schematic fragment but you can see it in the top center of the complete schematic (see previous sections). Anyway, during Receive this creates the proper 12V reverse bias conditions in the SW1 and SW3 switches, diodes D1 and D7 respectively, so that they are "OFF".

Now we come to the most complex of the "switches", SW2 (in my block diagram above), which is the Receive bypass switch.

This is a very interesting part of the circuit.

Not shown on this fragment (but are shown on the main complete schematic) are the usual DC blocking capacitors, in this case C1 and C16 (both 1uF).

Now there are two diodes making up the switch, which are D3 and D5 (both 1N4007). Why two? Because as I mentioned somewhat previously, a substantial off isolation is required here, to ensure that under all circumstances there is not enough leakage through the switch to create a positive feedback loop which creates spurious self-oscillation of the

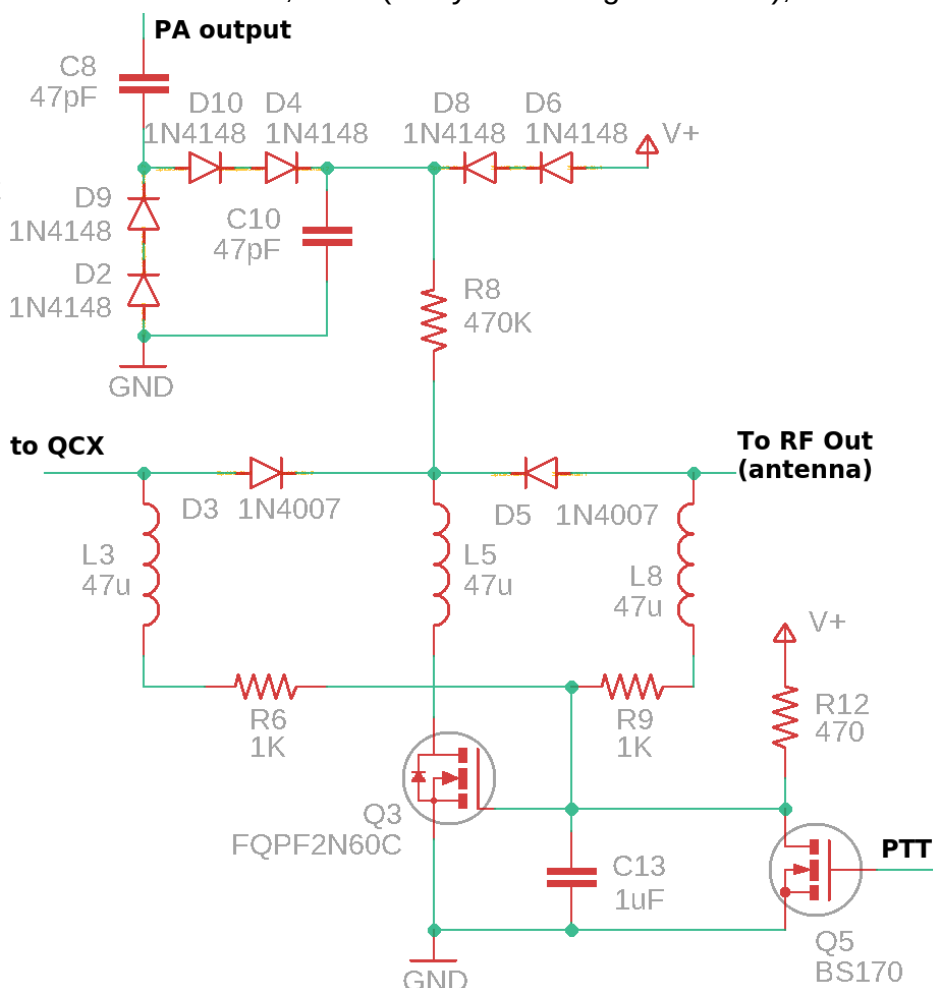

power amplifier. Actually, two diodes back-to-back is probably overkill. One diode should provide sufficient Off isolation. But during the development I was plagued by huge spurious bursts at the instant of transmit/receive switchover – exactly as described by Pat G3VA (SK, RIP)! This was very difficult to tame, but very educational – more on this a little later.

An additional benefit of two diodes back-to-back is that in this application, if there IS any intermodulation distortion (IMD) it gets kind of “canceled out” to some degree, when two back-to-back diodes are used. Again, I believe overkill in this application where the diodes are completely On or Off. But having this extra diode in the circuit is an additional belt-and-braces, take-no-chances, zero-risk-tolerance approach that leaves a safe and comfortable feel-good impression.

You can again see the RF-blocking diodes L3, L5 and L8 (all 47uH) to prevent RF leaking into the bias control circuits.

During Receive, the PTT signal is low (0V) and therefore MOSFET Q5 is switched Off... this results in the supply voltage reaching the gate of Q3 via R12, which switches Q3 on and pulls current through L5, from the D5 cathodes to ground. Forward bias current is driven through diodes D3 and D5's anodes via R6 and R9 (both 1K) which delivery current via R12 (470-ohms).

Ignoring voltage drops anywhere, we can calculate the forward bias current through D3 and D5. R6 and R9 are effectively in parallel, with a resistance of half 1K i.e. 500-ohms. This is in series with R12 (470-ohms) so the total resistance is 960-ohms. The current through R12 will therefore be $12 / 970 = 12\text{mA}$ at 12V supply and $20 / 970 = 20\text{mA}$ at 20V supply; this current is shared between D3 and D5 equally. The forward bias current in each diode is therefore 6-10mA for supply voltage 12-20V; this is plenty of forward bias current to leave the switches well turned on and result in very low insertion loss that is negligible in the Receive signal path.

What of the OFF condition? Here the situation is a little more complex. Remember the first rule of PIN diodes? “To switch a PIN diode off, thou shalt apply a reverse voltage that is larger than the peak-to-peak voltage of the applied RF”? 50W of RF is 141V peak-to-peak and therefore we need more than this, as reverse bias, to switch off the diodes! Where will we get ~150V DC for reverse biasing these diodes? While Don W6JL had available 350V from the screen grid of the valves (tubes) in his transmitter – we have no such luxuries available here.

The very neat solution is to “borrow” a little energy from the PA output itself! Then voltage double and rectify it. The result is a nice clean DC which is always more than the peak-peak of the signal, and plenty enough to reverse bias the diodes so they are always perfectly and completely OFF.

This doubler section of the schematic is shown here (right). C8 is connected straight to the PA output (before even the Low Pass Filter – so that we can pick up any nasty spiky waveforms, warts and all).

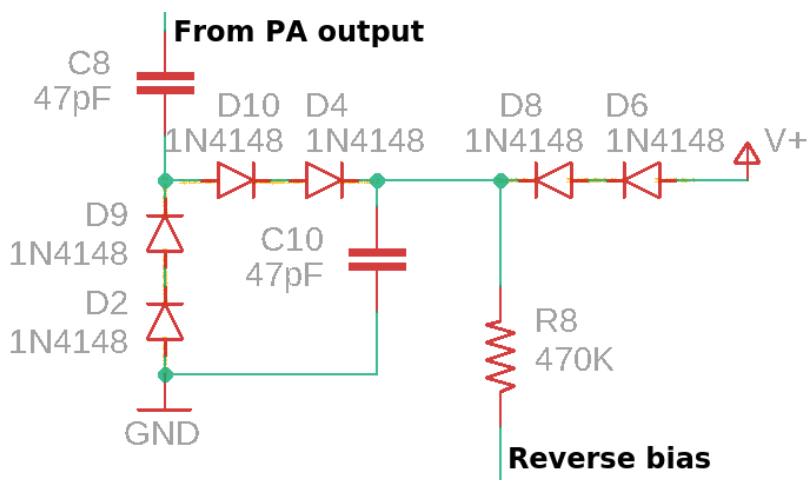

D2/9 and D4/10 together with C10 provide the voltage doubler and rectifier. Resistor R8 (470K) supplies this reverse bias to the diode cathodes. The current demand is incredibly small, just leakage through diodes and MOSFETs that are OFF... so 470K, a large resistance, works just fine.

To get things started, in the absence of any signal, I also pass in the supply voltage via D6/8. That ensures that the switch is “off” even when there is no RF signal.

What about the fact that the diodes are all implemented by two 1N4148 diodes in series? Why? Because, according to the datasheet (Vishay, but all the manufacturers are similar), the absolute maximum rating for a 1N4148 “Repetitive peak reverse voltage” is 100V; the “Reverse voltage” is 75V. Therefore we will easily breach these conditions with 50W power.

I looked for other commonly available small signal diodes but could not find any which had the right combination of:

- Easy availability, common everywhere
- Low cost
- High reverse voltage specification
- Fast reverse recovery time (so that I could be confident that the diodes would accurately rectify and double the RF)

The easy solution was then just to make each diode of the doubler from two in series. 1N4148 are easily available, inexpensive, and fast. Two in series doubles the reverse voltage specification and makes it adequate for the task. There will be a tiny leakage through the diodes which will suffice to balance the workload between each diode of the pair.

The fact that the doubler voltage is somewhat larger than the peak-to-peak RF voltage, and the fact that the entire amplitude of the RF voltage never arrives instantaneously – because there is envelope shaping provided by the QCX to prevent key-clicks (which, by the way, would be all the more important when transmitting 50W than at QRP power levels) – means that the voltage available at the doubler output is always higher than the peak-to-peak of the RF. As the RF amplitude rises, relatively slowly over the course of a few milliseconds, the doubled voltage does not instantly keep up because the rectifier capacitor has to charge up – but it is nevertheless always “ahead” of the RF! I love it when a plan comes together (TM – Hannibal Smith, A-Team).

Therefore this doubler circuit works very well to provide a large (but low current) DC voltage to the Receive diode switch to keep it OFF during transmit.

Now, you might wonder why I used BS170 transistors for the N-type MOSFETs Q5 and Q6; and Q4 is a P-type IRFU9024 of course; but why the TO220-package FQPF2N60C for N-type Q3? What is that about? That is another subtle design problem arising during the development!

The problem arises when you observe the waveform at the Q3 drain, when the Q3 transistor is a BS170. You see these horrible spikes! In the ‘scope trace (right) the top trace is the RF output waveform (151.4V peak-peak is 57W); the lower trace is the signal at Q3’s drain. We have a lot of horrible spikes. Why?

The answer is in the BS170 datasheet (ON Semiconductor version, in this case – but again they are all the same). The “Maximum Ratings” section specifies the maximum Drain-

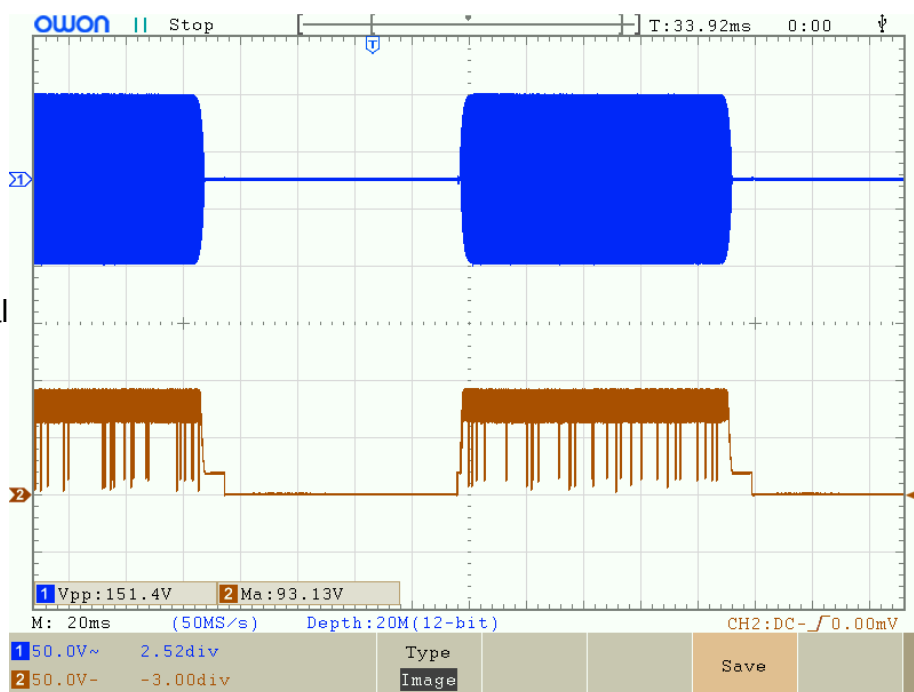

Source voltage as 60V DC. Well – here we are applying much more than that! More like ~150V DC! Severe abuse of the BS170!

The phenomenon seen in the 'scope trace is known as Avalanche Breakdown. A quote from Wikipedia https://en.wikipedia.org/wiki/Avalanche_breakdown:

“Avalanche breakdown is a phenomenon that can occur in both insulating and semiconducting materials. It is a form of electric current multiplication that can allow very large currents within materials which are otherwise good insulators. It is a type of electron avalanche. The avalanche process occurs when carriers in the transition region are accelerated by the electric field to energies sufficient to create mobile or free electron-hole pairs via collisions with bound electrons.”

Apparently one can go quite deeply into Semiconductor Physics and Quantum Mechanics... but let's NOT do that. Suffice it to sweep a lot of theory under the carpet and say that the BS170 junction doesn't like that huge violation of its specification at all and the junction “breaks”, the insulator becomes a conductor for a short time, shorting the DC to ground and no doubt discharging C10 instantaneously, which lowers the DC voltage and allows the BS170 to recover its cool.

Such things would be liable to fry a transistor, but the large 470K resistor and the small size of the rectifier capacitor C10, I think here limits the potential damage, and the BS170 transistor survives. However, it's unpleasant to think of such unpleasant things going on. You can even actually HEAR it in the QCX earphones during transmit, it appears as a quiet random noise superimposed on the sidetone during transmit. When you understand where it comes from, it's irritating. Unforgivable, even!

The solution is quite simple! Just use a more manly transistor for Q3. The FQPF2N60C is a 600V 2A transistor in a TO220 package. That's more manly than manly. That's like having the world-champion bodybuilder come along and help you carry your weekly supermarket shopping to your car. But... it turns out the device is low cost and easily available, and that's good enough. I don't need to waste time or pay more, finding a 200V 20mA device. Sometimes the world champion bodybuilder shows up and though you weren't looking for him particularly, he'll do just fine.

Now take a look at the beautiful results... after the new transistor substitution... again with the RF on the top trace and the Q3 voltage on the bottom – now the RF power shows here as 63W; the voltage at the Q3 drain is around 150V, and has a lot less ripple on it too (probably due to lower leakage of the high impedance high voltage supply).

Note also the little 20V “pedestal” on the right-hand side – this is caused by the PA supply voltage coming through D6/8 as I mentioned, in the absence of any RF.

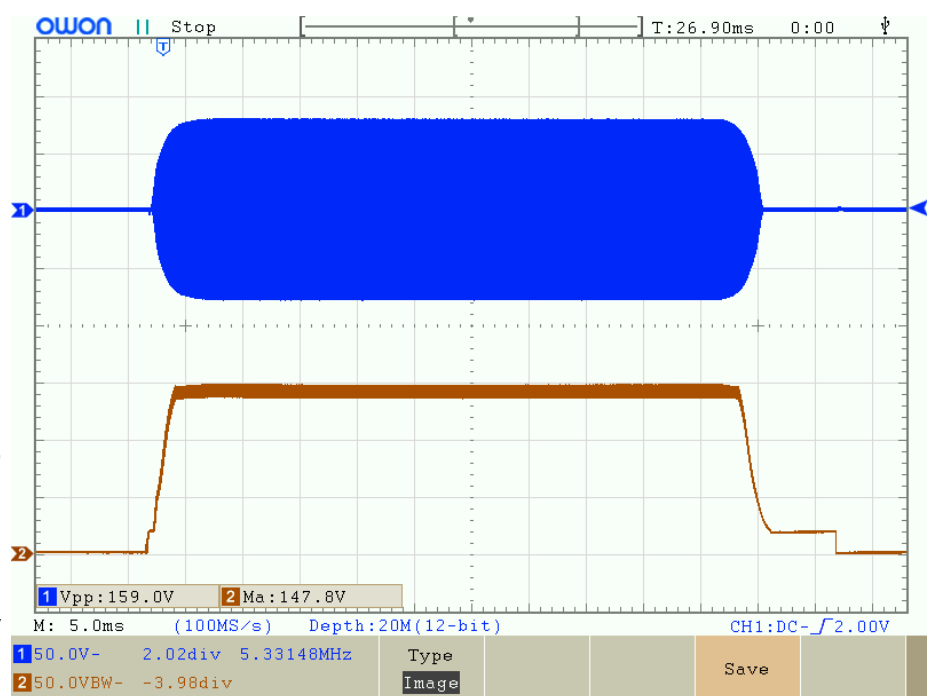

A final confirmation is provided by the now clean-sounding sidetone in the QCX earphones during transmit. Problem comprehensively solved! Done!

One final problem in the Transmit / Receive switching consumed a good solid 2 days of investigation, and was both highly educational, interesting and satisfying to solve.

This problem is shown here in a photograph of the oscilloscope screen, which shows a single Morse code “dit” at 24 words per minute (duration 50 milliseconds). The lower (yellow) trace shows the PTT signal from the QCX – 0V during Receive, and +5V during transmit (plus a bit of RF interference that we can ignore). Note that the PTT is released a short delay after key-up (something like 10 milliseconds), this allows the RF envelope shaping to decay the RF amplitude to zero gradually, avoiding key-clicks.

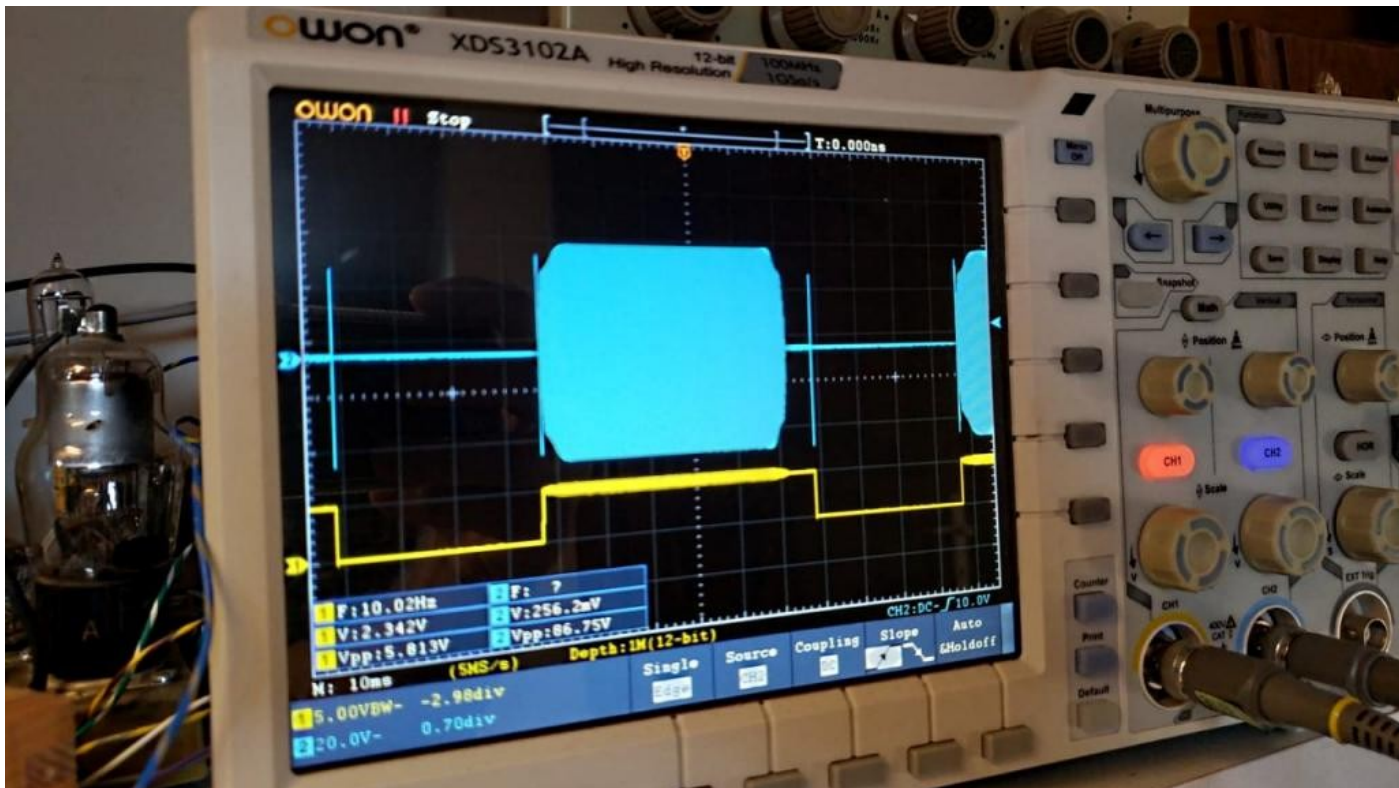

With a modern digital storage oscilloscope we can record a complete slow sweep such as this with a high sample depth (I used 40 million at 12-bit resolution). I can then freeze the display with a Single trace storage, and use the timebase adjustment and horizontal shift controls to “Zoom in” on the offending spike. This amazing feat of modern technology lets me take a very close look at those offending spikes, and better understand their origin.

Here’s the zoom (right) with horizontal scale 2us/division.

These horrible spikes occur on the Transmit/Receive transition in both directions, Receive → Transmit as well as Transmit → Receive.

The spurious burst of oscillation is huge, around 200V! It is not at the operating frequency. It would not be

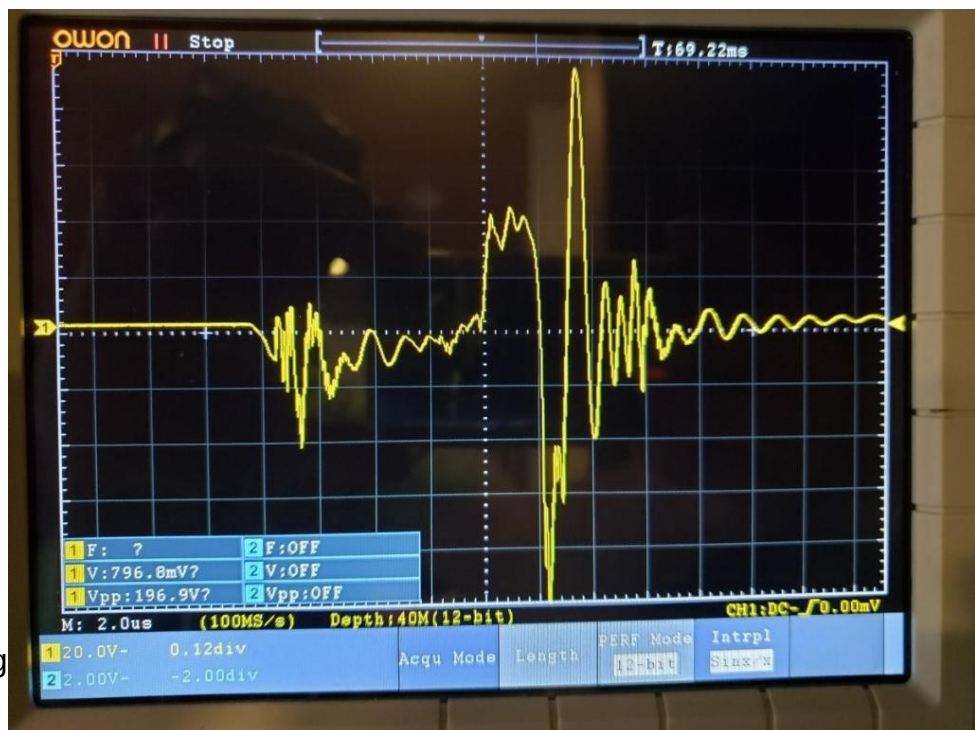

heard by the other station. The frequency is not stable or exact, but appears, based on the timebase, to be something around 1MHz-2MHz, then a bit under 1MHz as it dies away. The whole thing is all over in 20-25us. Though the other station would not hear anything on the operating frequency, nevertheless the signal is a large spurious signal which could cause interference to someone somewhere. And once we know about such a horrible thing, we can't sleep peacefully at night leaving it like that. And Pat Hawker G3VA (RIP) would surely be have been horrified had he heard of QRP Labs doing such a thing.

The cause is easy to explain now, but was very hard to find, at the time. I tried adding things here and there, and I could change the shape of the spike. Or move it around. Remove it at the end, or the start of the transmission, but not both. But not easily eliminate it. A clue was that this spike is nothing to do with the actual RF transmission – if it was, it would be possible to correlate the spike to the start and end times of the RF envelope; but in fact the spike commences at the moment of Transmit/Receive transition (PTT signal state change).

The actual cause, is positive feedback around the amplifier! I'm sure you've been at some public event, where a speaker is holding a microphone. Someone has something adjusted wrongly, and you get a huge loud squeal in the Public Address (PA, not *this* PA)... the squeal is again nothing to do with the voice of the speaker. It is positive feedback – a loud enough sound makes it back from the loudspeakers, through the losses of the air, and into the microphone – to be amplified and go around the same loop fast enough to create a spurious signal, the "squeal". Here the same thing happens, but at RF.

The cause is that these PIN diode switches we love so much, are not perfect, instantaneous switches. They don't switch on or off in zero time. They don't go from near zero resistance to near infinite resistance immediately in zero time duration. In reality they go through some part-way state for a fleeting moment before they settle in their new state. For a tiny moment, the three conceptual switches in the project, "SW1", "SW2" and "SW3" are all "partly-on" at the same time! This allows RF energy to flow in a loop, back from the output of the power amplifier, to its input – getting bigger each time around the loop, quickly building up into this huge spike of energy. Then as one branch of the switch(s) become properly "Off" the oscillation dies out and normal service resumes.

The solution to this problem, is that we need some delays. Some sequencing. I had to make sure that all of the switches are OFF for a short while, before the other switch(s) are turned ON. It is the electronic equivalent of what in a more expensive mechanical switch, a rotary switch perhaps, would be termed "break-before-make" - it ensures that the switch wiper is never connected to two terminals at the same time. There is a "break" before it contacts the next output terminal.

In the circuit, this was implemented simply by the addition of two capacitors C5 (22nF) and C13 (1uF), and resistor R15 (previously the PTT control input was connected directly to the Q6 gate).

Consider the two circuit fragments containing Q6 and Q5:

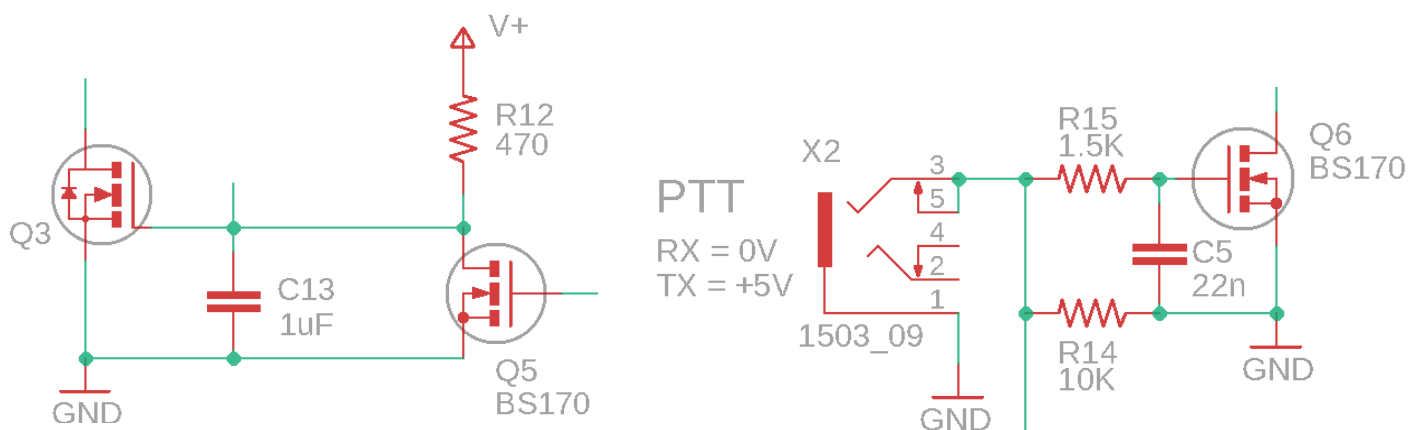

Dealing first with the Receive → Transmit transition; PTT is initially at 0V. The transistors Q5 and Q6 (above left) are therefore OFF. The Q5 gate is connected to PTT so when PTT goes to +5V (on key-down), Q5 is switched on; this pulls the gate of Q3 to ground (0V) so Q3 is switched off. With Q5 on and Q3 off, reverse bias voltage is applied to diodes D3 and D5, causing them to be switched OFF; so the Receive bypass switch “SW2” of the circuit is OFF. The important point is that this all happens extremely quickly, there is no delay.

At Q6 however (above right), there is a resistor-capacitor network R15 & C5. This delays the voltage rise at the gate of Q6, delaying the turn-on of Q6; Transmit is enabled (switches “SW1” and “SW2” closed) when Q6 is on. Therefore the combined effect of the immediate switch off of the Receive switch (“SW2”) and the delayed turn-on of the transmit switches (“SW1” and “SW3”) perfectly creates the required break-before-make timing. The positive feedback condition cannot arise and there is no big spurious spike on key-down switching!

On the transition from Transmit → Receive, PTT changes from +5V to 0V. Q5 is switched off immediately. The voltage at the Q3 gate rises but this is not instant; it is delayed as C13 has to be charged up via 470-ohm resistor R12. So there is a delay before “SW2” is closed.

The turn-off of Q6 (transmit PA switches “SW1” and “SW3”) is also delayed, as C5 discharges through R15 (1.5K). This discharge is faster than the charging of the “SW2” capacitor C13, which is charged through 470-ohms but is 1uF. The positive feedback situation is completely avoided.

The choice of component values is quite non-critical, I chose the capacitors after some rough calculations of approximate values from the time-constant (product of resistance and capacitance) They were found to work, the positive feedback condition is reliably voided so there is no more huge spike at turn-on and turn-off.

7 Amplifier set-up and operation

7.1 PA Precautions

To avoid dramatic failure of components, observe the following precautions:

- 1) Check all the components again, and again, BEFORE applying power to the amplifier! Check the resistors are in the correct places, check that all the enameled wire inductors and transformers are properly soldered with continuity through the windings. The same applies to diodes, transistors and the voltage regulator IC. Pay particular attention to ground connections of all components: A very common fault is failure to apply adequate heat to ensure a good solid joint to ground – the ground plane will dissipate heat and draw it away from the joint.
- 2) **Before applying power, make sure the R5 trimmer resistor (PA bias) is turned all the way anticlockwise.**
- 3) Check for short-circuits between the IRF510 metal tab, and ground! Check that there are no other shorts, the DC resistance between the +12V tab and Ground should NOT be near zero.
- 4) Do not apply power to the amplifier unless the heatsink installation has been performed and all screws are tightened.

- 5) On first powering up the amplifier, and during adjustments, use a current-limited supply. If anything does go wrong, you'll have more time to notice it before letting the smoke out.

7.2 Power supply

For full 50W power output the PA requires a supply of 20V at about 5 or 6A. Ensure you are using a power supply which is up to the job! The power supply needs to be capable of supplying full current suddenly without any voltage drop on key-down. Use THICK cables from the power supply to the amplifier, to avoid voltage drop.

Note that the QCX should not be powered by the same 20V supply, even if the power supply is capable of supplying the additional current required by the QCX. A supply voltage of 20V is too much for a QCX.

If you wish to operate the whole project from the same 20V supply, then use a voltage regulator such as 7812 (with a suitable heatsink) to drop the voltage to 12V for the QCX.

Alternatively, you could run both the QCX and the PA at a lower voltage, which will give a final power output of less than 50W (please refer to the measurements in the later section).

7.3 Connection to QCX

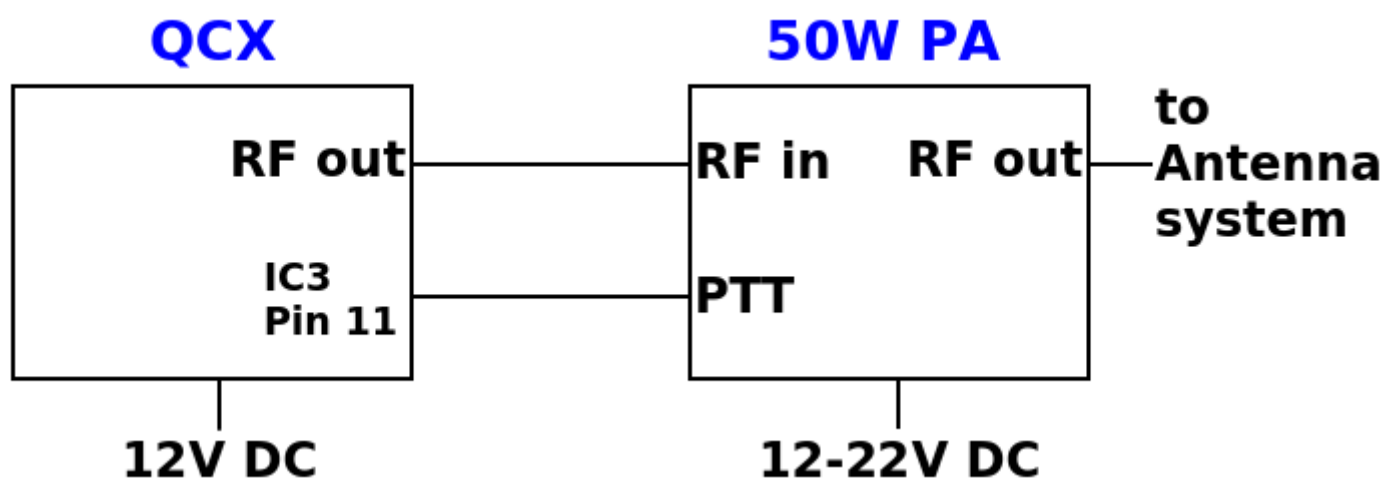

The diagram shows an appropriate connection between the QCX and the 50W PA kit.

A simple coaxial cable is used from the QCX RF Out to the 50W PA RF In (note, Out/In nomenclature here assumes the system is in the transmit state; naturally the direction of signal flow is reversed during receive).

The QCX should be operated at 12V supply. A full 5W of power output is not necessary to drive the power amplifier to full 50W output and will over-drive the amplifier, causing potential distortion and glitches. With 12V supply the slightly lower QCX Power output will be perfect. A 7812 voltage regulator (TO220 package) with heatsink is a perfect way to power the QCX, if you wish to operate both the QCX and the Power Amplifier from the same supply.

The "PTT" (Push To Talk) or Transmit-enable signal requires a 3.5mm stereo plug to connect to the 50W PA board. Connect the "Sleeve" to ground, and the PTT signal to the "ring". The tip can be left unconnected as the socket in the 50W PA does not have a connection to this pin. At the other end of the cable, connect the ground signal to QCX ground, and the "ring" PTT to IC3 pin 11 of the QCX. This signal goes high (+5V) when the QCX keys its own 5W power amplifier.

The output of the 50W Power Amplifier connects directly to the antenna system – which could include matching units or tuners. Do not transmit at full power into a mismatched (high SWR) antenna system.

It is strongly recommended to connect a 10K resistor in the QCX from IC3 pin 13 to IC3 pin 14. This modification is detailed further, here:
<http://www.grp-labs.com/qcx/qcxmods/ptt.html>

7.4 Adjustment

There is only one adjustment required in the 50W PA kit, which is the R5 trimmer potentiometer.

Initially, **BEFORE POWER UP, MAKE SURE R5 IS FULLY ANTI-CLOCKWISE.**

To make the adjustment, use a power supply with a current measurement readout, or use a DVM in current measurement mode in series with the 50W PA.

Set up the QCX as follows:

- 1) Enable Practice mode (set Practice mode to ON in the Keyer menu)
- 2) Set Keyer mode to “Straight”.

This will allow you to use the microswitch key the QCX, which in turn will key the 50W PA (generate a “high” +5V signal on the PTT line) which puts the 50W PA kit into the Transmit state. However since the QCX is in Practice mode, no RF is generated – this is very important.

With R5 turned all the way fully anti-clockwise, press the microswitch on the QCX to key the 50W PA. Observe the current consumption of the 50W PA kit. For example, suppose the current consumption is 85mA. Then turn the R5 trimmer potentiometer very slightly clockwise, a tiny little bit at a time, until you see the current consumption just rise above 85mA. This is a very fine adjustment – going to far beyond this point will cause a very high current to flow. Once you have found this point where the current just started to increase above 85mA, then turn it a tiny bit anti-clockwise again to just put it back at 85mA again.

NOTE: 85mA is only my example; the value depends on supply voltage and you should always refer to your observation of the current consumption when R5 is fully anti-clockwise.

Now your 50W HF PA kit is ready to use!

7.5 Supply voltage value and power output

Note that the output power depends on the supply voltage. Full 50W power output is obtained at a supply voltage of around 19-22V. The exact value also depends on other things like the setting of the R5 trimmer potentiometer, the band, and the drive power from the QCX.

Refer to the power output vs supply voltage charts in the Measurements section of this manual for a good guideline.

It is recommended NOT to operate this power amplifier at power outputs in excess of 50W. This will cause too high voltage for the IRF510 transistors and too high power dissipation and will likely lead to failure of these transistors.

Similarly do NOT operate at a setting of R5 beyond the recommended setting (see previous section). A higher setting (more clockwise) can produce more power output for a given supply voltage, but it also increases the risk of spurious output and glitches.

8 Measurements

8.1 Power output vs Supply voltage

This is a measurement of output power vs supply voltage for the production models assembled for testing. In each case (each band 80, 40, 30 and 20m) the input power was provided by a QCX powered at 12V supply. The power was measured as 3.2W into a 50-ohm dummy load in all cases. Then the dummy load was removed and a short coaxial cable used to connect the QCX output to the 50W PA input. The 50W Power Amplifier set-up adjustment was as per section 7.4. A 50-ohm dummy load was used at the output of the 50W PA and the peak-peak voltage measured using an oscilloscope.

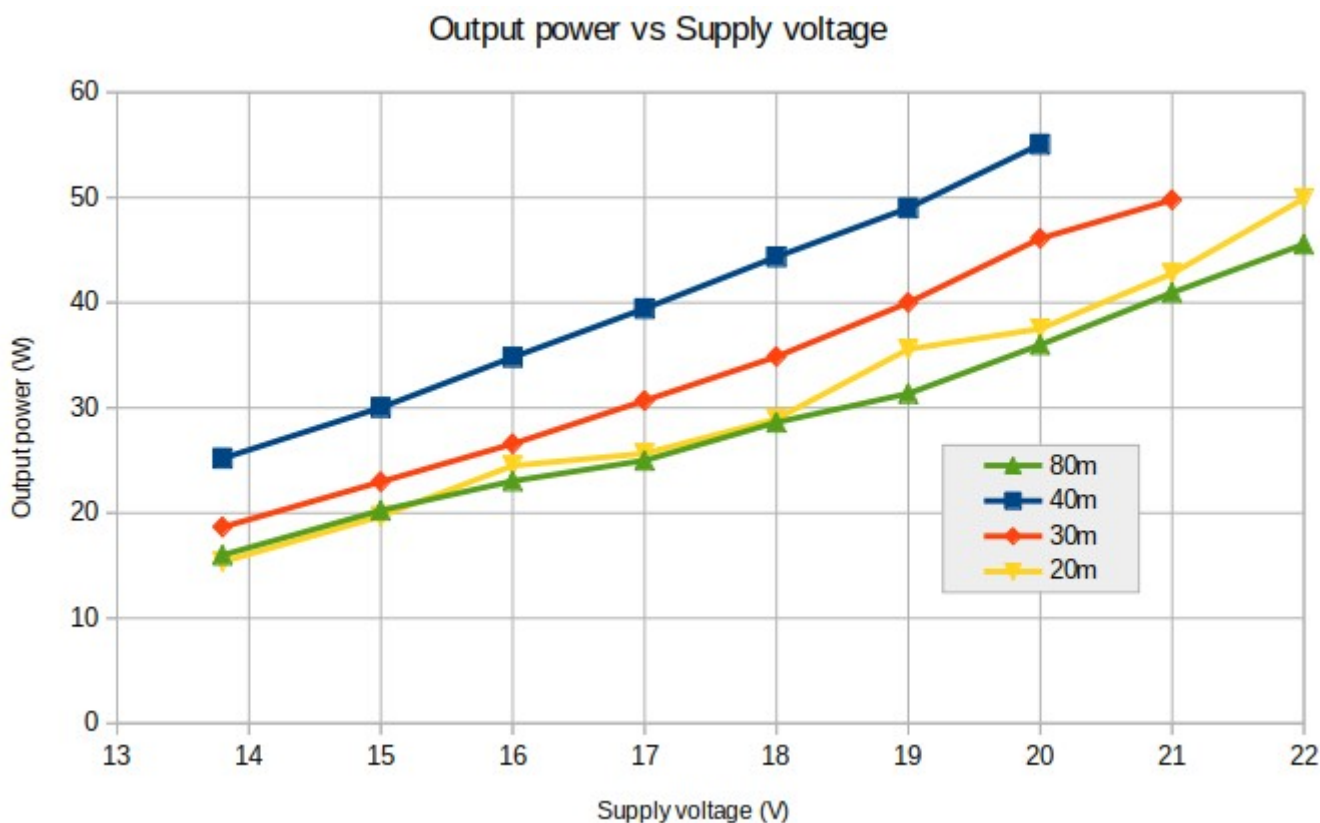

8.2 Low Pass Filter characteristics

These measurements show the filter characteristic of the Low Pass Filter section only. An Advantest R3361C Spectrum Analyzer with Tracking Generator was used. BNC connectors were soldered to the LPF filter and output and connected to the spectrum analyzer using 50-ohm coaxial cables.

40m: right
 30m: below left
 20m: below right

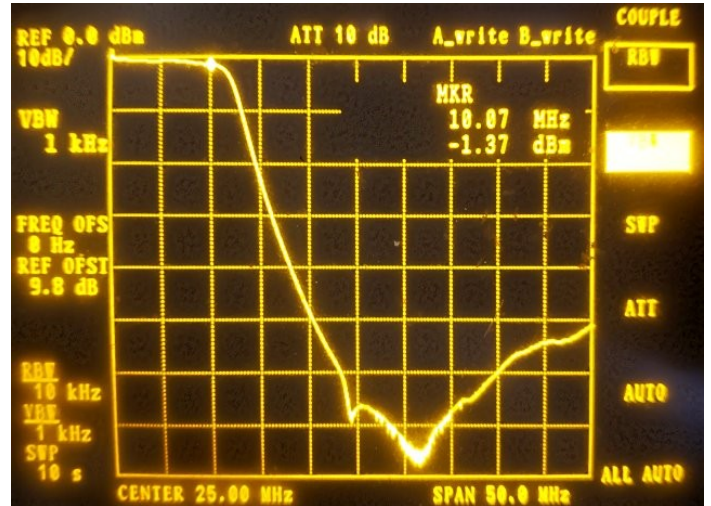
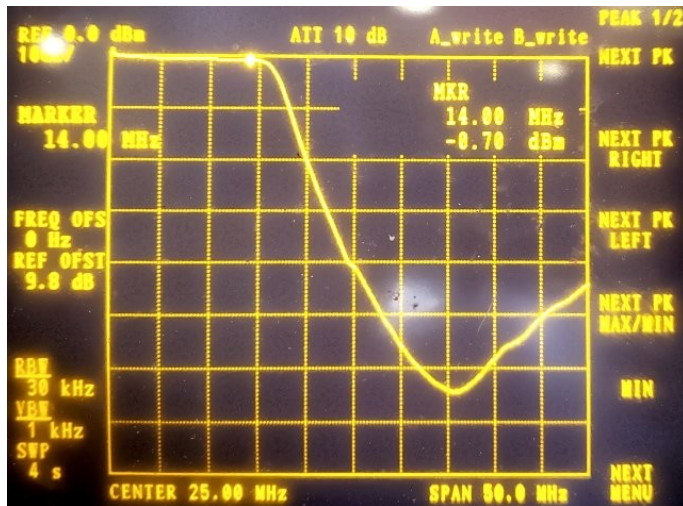
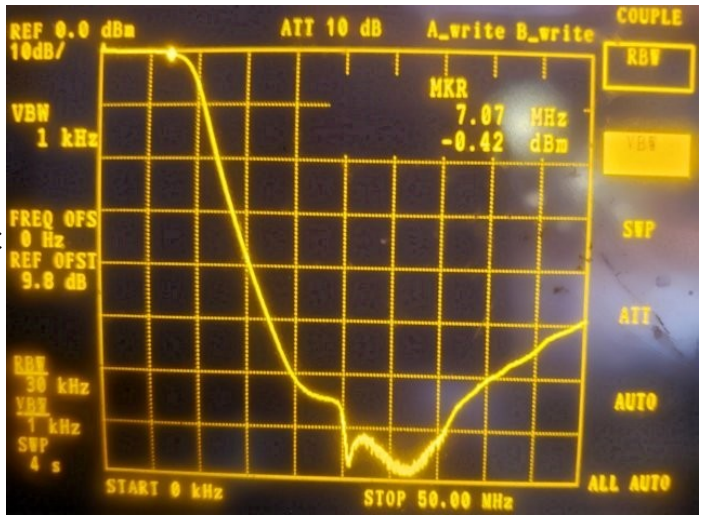

8.3 Keying envelope

The oscilloscope trace below shows a single 24wpm CW "dit" (50ms duration) on 40m at 54W power output.

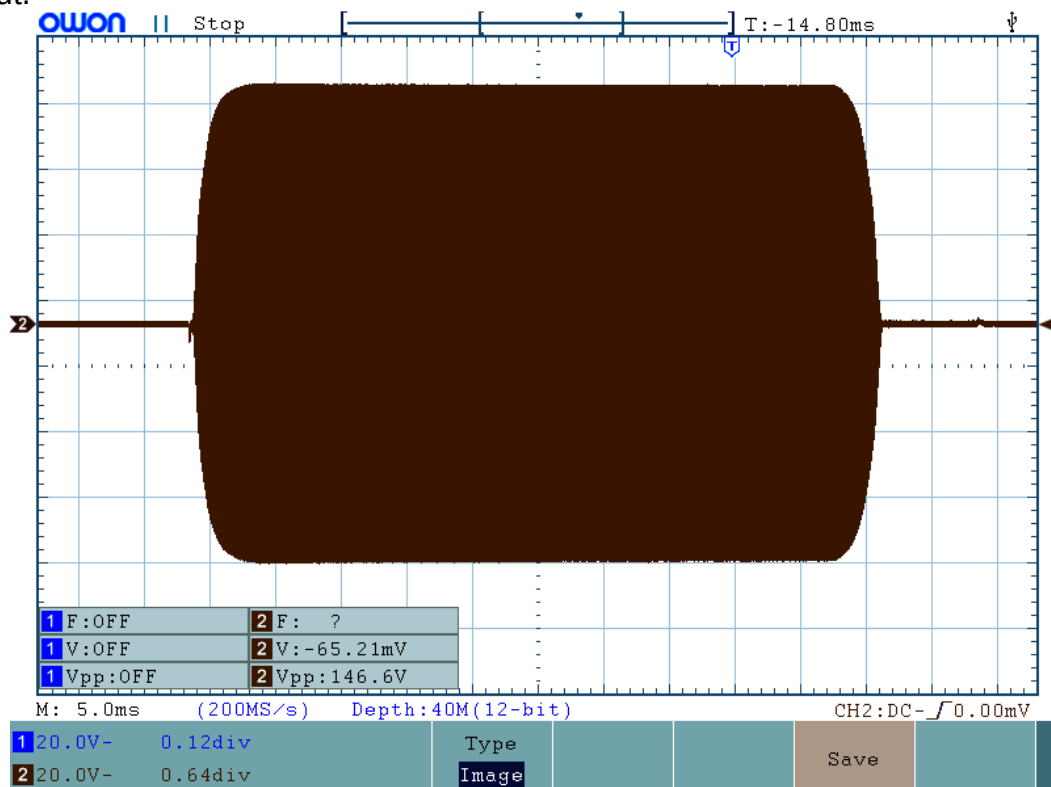

This is a zoom on the trailing edge (key-up) with 1ms/division setting on the oscilloscope.

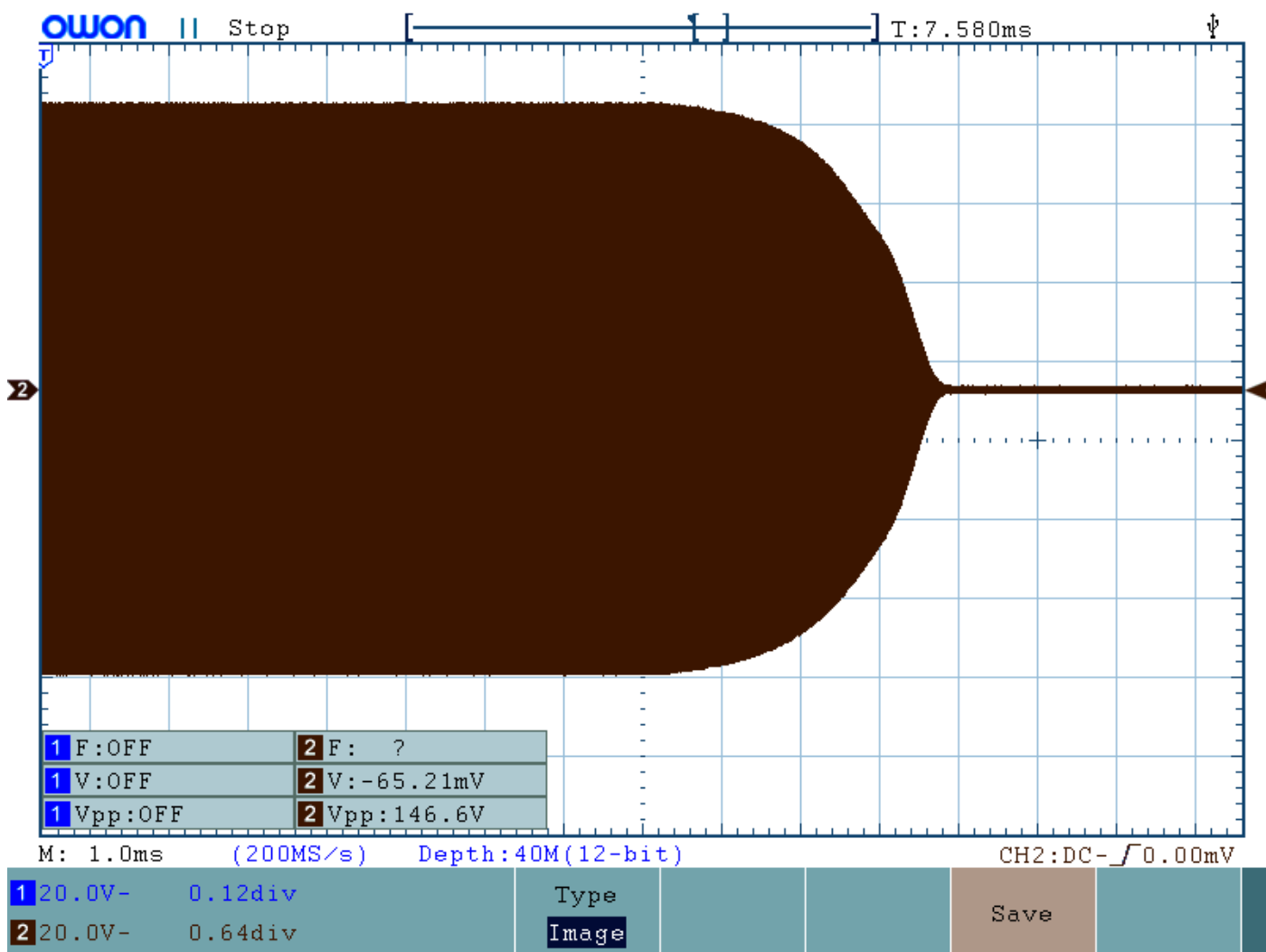

9 Version History

1.00	12-Dec-2019	First version
1.00a	12-Dec-2019	Added missing values for 30m LPF inductors
1.00b	12-Dec-2019	Correct wrong title of section 3.13
1.00c	13-Dec-2019	One wrong diagram in the description of switch SW3
1.00d	13-Dec-2019	Corrected various typos (thanks Fred VK2WS)
1.00e	13-Dec-2019	Corrected one more typos (thanks Fred VK2WS)
1.00f	13-Dec-2019	Corrected more typos and fixed the problem with my spellchecker and ran it (thanks Richard G4TGJ)
1.00g	18-Dec-2019	More typos (thanks Paul AI4EE and Dennis Shelton)
1.00h	02-Jan-2020	Fix diagrams LPF capacitor nomenclature Fix typo in 1K colour code (thanks Dave Wheeler)
1.00i	03-Jan-2020	Fix one more typo (thanks Fred VK2WS)

1.00j	06-Jan-2020	Fix typo (0.1uF should be 1uF, thanks Jon W8REA) Continuity test wrong in 3.6 (thanks Paul AI4EE & George SV2SBE)
1.00k	01-Jun-2020	Corrected C/W typo on page 50; edited page 56 explanation about overheating capacitors, which are not caused by reactance.
1.00l	12-Jun-2020	Updated for PCB Rev 2 and building for 80m operation
1.00m	16-Jun-2020	Clarification of section 3.6 continuity tests
1.00n	16-Jun-2020	1.5K resistor can be 5-band colour code Removed 7.1 sentence about capacitor polarity (there are none)
1.00o	01-Oct-2020	Added power output measurement for 80m in section 8.1
1.00p	05-Oct-2020	Replaced photos showing incorrect Q3 installation in section 4 (thanks to Bob KG5SQJ for the new photos)
1.00q	12-Oct-2020	Added details of the alternative 5-band colour codes sometimes supplied for some of the resistors