

Band Pass Filter Kit



1. Introduction

A band pass filter (BPF) is used at the front end of a receiver, to attenuate strong out-of-band signals. Strong signals that reach the receiver's first mixer and/or RF pre-amplifier cross-modulate and produce unwanted spurious responses at the receiver output. The QRP Labs BPF PCB has a 4-pin plug at its input and output. The PCB size and pinout are the same size as the Low Pass Filter kit, so this BPF kit can also be used in the QRP Labs relay-switched filter kit.

The kit is supplied with high-quality low-loss class-1 dielectric (CC4) RF ceramic capacitors of the C0G type (NP0, meaning near-zero temperature drift). These have very good performance at high frequencies.

The QRP Labs BPF kit uses the well-known double-tuned circuit filter. There are two resonators, each one is made from an inductor and capacitor in parallel. These are coupled together by a small capacitor. In this kit, the resonator is made up of a toroidal inductor, in parallel with a fixed capacitor and a trimmer capacitor. The trimmer capacitor is used to make minor adjustments to the resonance frequency of each resonant circuit.

The coupling capacitor is made up of two parallel capacitors C3 and C4 on the PCB. In most of the filters, only one capacitor is used. However in some cases two are used in parallel to achieve the required coupling capacitance.

Additional small windings are used on each toroid, turning them into a transformer. These short windings form the input and output of the filter. The turns ratio is chosen to achieve approximately 50 ohm input and output impedance, to suit most amateur radio receiver antennas and circuits.

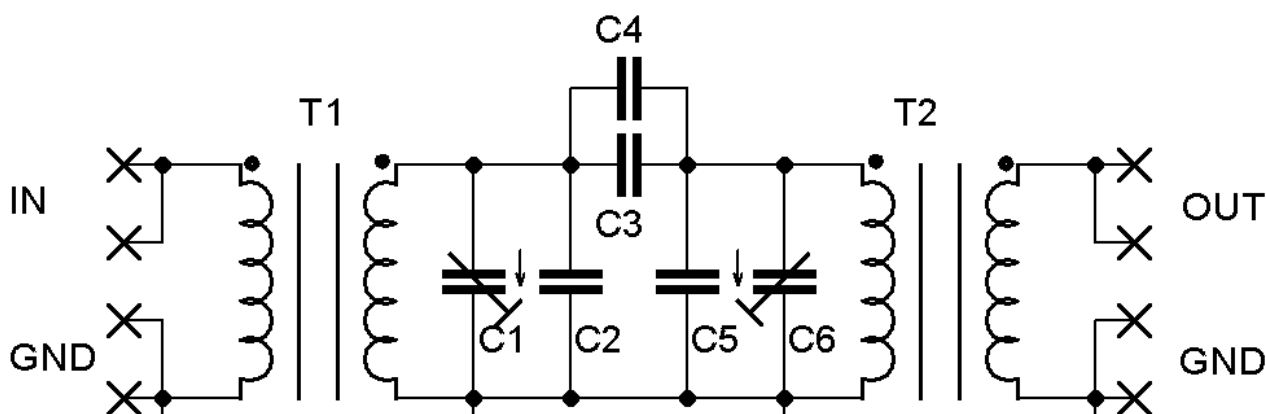

Please read and follow this assembly manual carefully, step by step. The band pass filters require careful construction and adjustment. Generally the adjustment is more difficult for the lower frequency bands.

2. Parts List

Please refer to the parts list below, for your band.

Band	C1, C6	C2, C5	C3	C4	T1, T2	Extra
160m	30p trimmer	820p ("821")	56p ("560")	22p ("220")	T50-2, 8.56uH, 7:40t	12p ("120")
80m	30p trimmer	470p ("471")	39p ("390")	10p ("100")	T37-2, 3.83uH, 6:30t	12p ("120")
60m	30p trimmer	220p ("221")	10p ("100")	5p ("050")	T37-2, 4.12uH, 6:31t	
40m	30p trimmer	150p ("151")	10p ("100")	5p ("050")	T37-6, 3.02uH, 6:31t	
30m	30p trimmer	100p ("101")	8p ("080")		T37-6, 2.11uH, 5:25t	10p ("100")
20m	30p trimmer	68p ("680")	6p ("060")		T37-6, 1.53uH, 4:21t	10p ("100")
20m	30p trimmer	56p ("560")	6p ("060")		T37-6, 1.79uH, 4:24t	
17m	30p trimmer	47p ("470")	4p ("040")		T37-6, 1.41uH, 3:19t	10p ("100")
15m	30p trimmer	33p ("330")	3p ("030")		T37-6, 1.14uH, 3:18t	10p ("100")
12m	30p trimmer	22p ("220")	3p ("030")		T37-6, 1.10uH, 3:17t	10p ("100")
10m	30p trimmer		2p ("020")		T37-6, 1.40uH, 3:16t	10p ("100")

Important notes

- 1) **20m BPF** may be supplied with either 68pF or 56pF capacitors. Wind the corresponding number of toroid turns for the row corresponding to the capacitor values supplied in your kit. Note that 56pF capacitor labels may be "560" or "56" or something like "56J". All are 56pF.
- 2) All bands have the same pair (C1 and C6) of 30p trimmer capacitors, which may be a green plastic trimmer with visible moving vanes, or a ceramic style trimmer capacitor. In both cases, the screw of the trimmer capacitor is grounded. This means that you can use an ordinary metal screwdriver for tuning, and it will not affect the capacitance.
- 3) Where the capacitor supplied is the ceramic type, it may seem at first that it is not possible to turn the screw; in fact it requires a bit more torque and you will find it turns fine.
- 4) Capacitors C2 and C5 are the same. In the above table the numbers in parenthesis indicate the actual marking on the capacitor. E.g. 10pF is marked "100". This is NOT 100pF! It is 10pF (because the first two digits are the value, 10; and the 3rd digit is the number of zeros). Be sure to check the printed capacitor value carefully before soldering – as it is difficult to remove the capacitor later. You may need a magnifying glass or jeweller's loupe to view the marked value clearly.
- 5) Capacitors C3 and C4 together in parallel make up the coupling capacitor between the two resonant circuits. The value of the total capacitance is largely responsible for the filter bandwidth (please see the discussion on bandwidth below).
- 6) Transformers T1 and T2 are the same (but wound in an opposite sense, to match the PCB holes – see assembly section below). In the above table, the meaning of the T1, T2 column is as follows. For example, consider the 30m value: "T37-6, 2.11uH, 5:25t". This means a T37-6 toroidal core is used, and the inductance of the main winding is 2.11uH. 25 turns of wire are used for the main winding, and 5 turns for the second winding (filter in/out).
- 7) The toroidal core T50-2 has diameter 0.5-inches (12.7mm) and is painted red. The T37-2 core has diameter 0.37-inches (9.4mm) and is painted red. The T37-6 core has diameter 0.37-inches (9.4mm) and is painted yellow.
- 8) All kits also include two 4-pin headers, and the PCB (size 1.5 x 0.5-inches, 38.1 x 12.7mm).
- 9) Two strips of wire are provided in the kit. The thinner of the wires is for the main (long) winding of T1 and T2. The thicker wire is for the second (few turns) winding.
- 10) For reasons connected with the component availability and kit packing, some kits may or may not have some surplus capacitors supplied. These are listed in the "Extra" column.

11)When winding the 40m, 60m, 80m and 160m filters' main windings, I recommend winding 4 extra turns than specified in the above table. This is because you will certainly need to change the number of windings to adjust the filter centre frequency. It is MUCH easier to remove a turn, than to add one (needs joining on another piece of wire etc). Please carefully read the section below regarding 40-160m band filter construction.

3. Filter characteristics

A very useful discussion on the double-tuned-circuit band pass filter can be found on the web page of Rob PA3CJD: <http://www.robkalmeijer.nl/techniek/electronica/radiotechniek/hambladen/qst/1991/12/page29/index.html>

The double-tuned-circuit band pass filter topology was chosen for this QRP Labs bandpass filter kit because it is a popular, tried and tested design. Over the years I have found it to work reliably. It can generally be built and adjusted without access to expensive equipment such as spectrum analysers or network analysers. Of course having access to such nice equipment is always a great way to experiment and adjust these filters.

In any band pass filter design there are always trade-offs. If you want narrower bandwidth, you must accept higher insertion loss. The unloaded Q of the toroids is a factor too. There are different methods of coupling the incoming and outgoing energy into/out of the tuned resonator circuit. In this kit I chose to use a second winding on the tuned circuit inductor. This is an easy way to approximate the desired 50-ohm input/output impedance without adding extra capacitor networks which would increase the physical PCB size, and the cost.

In this assembly guide, "bandwidth" means the -3dB point of the filter response shape. "Insertion loss" refers to the loss of the filter at its peak (centre frequency).

For many practical reasons there is considerable variation between the prediction of a theoretical model, and the experimental reality of a practically constructed filter. The PCB layout inevitably has stray capacitance and inductance. The toroidal core material has variation. The use of coupling windings has some effect too on the tuned circuit. For this reason the design of the filter values drew on various sources as well as theoretical prediction; but the final values were determined experimentally in some cases.

The coupling capacitor between the two resonators is the main determinant of the bandwidth, and insertion loss. I have chosen to target a bandwidth of approximately 1/10th the centre frequency, and insertion loss of under 2dB.

These filters are fascinating to experiment with! You may wish to experiment with different number of turns on the input/output coupling windings, with different size of coupling capacitor etc.

Section 4.6 contains a few notes distilled from the lab notebook during the final prototype build. These may be of interest to experimenters; they give an idea of the variation in insertion loss and bandwidth with different coupling capacitors, for example.

Section 5 contains the actual measured response curves, and bandwidth/insertion loss of the filters constructed using prototypes of this kit.

4. Construction

4.1 Parts placement

Parts placement is defined by the printed legend on the PCB. Please refer to the parts placement diagram below.

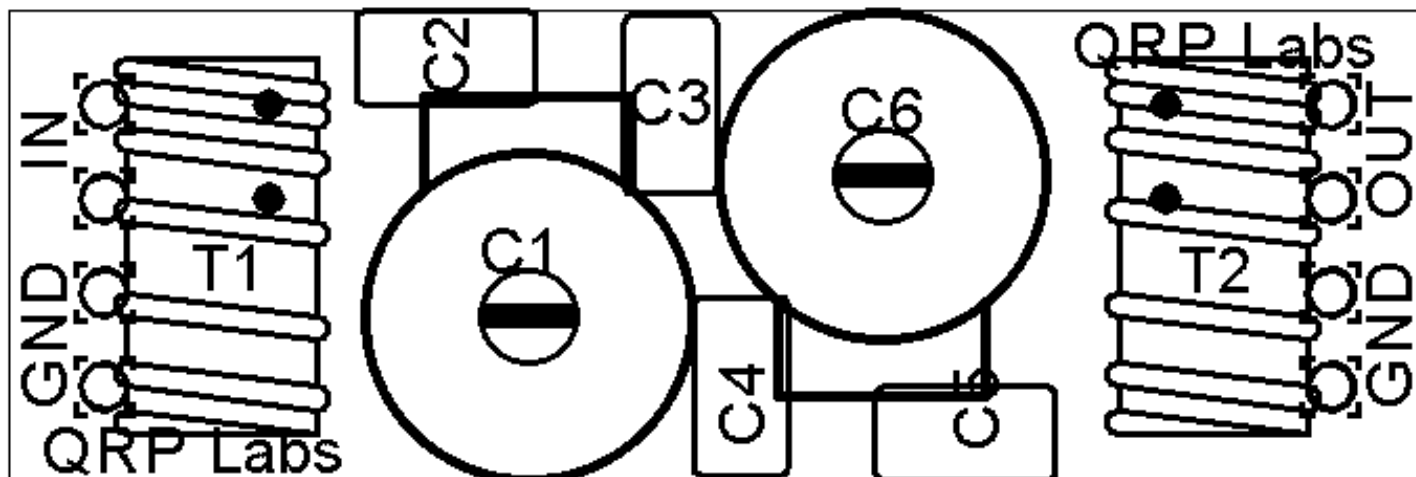

The PCB is quite small and the parts are close together. You are recommended to use a low wattage iron with a fine tip, and fine solder e.g. 1mm diameter or less. Take care not to overheat the PCB and risk damaging it. A well-lit area and magnifying glass may assist. Be careful not to bridge solder across closely-packed connections. I recommend checking with a DVM to make sure no solder bridges have been inadvertently created. Take care to ensure correct alignment of the 4-pin plugs.

The diagram below shows the PCB tracks connecting the various components. There is also a ground-plane of copper all around these tracks and holes, on both sides of the PCB. The small green circles are “vias” which connect the ground planes on the top and bottom of the PCB. All the grounded component wires are also connected to the groundplane, which is not indicated on this diagram.

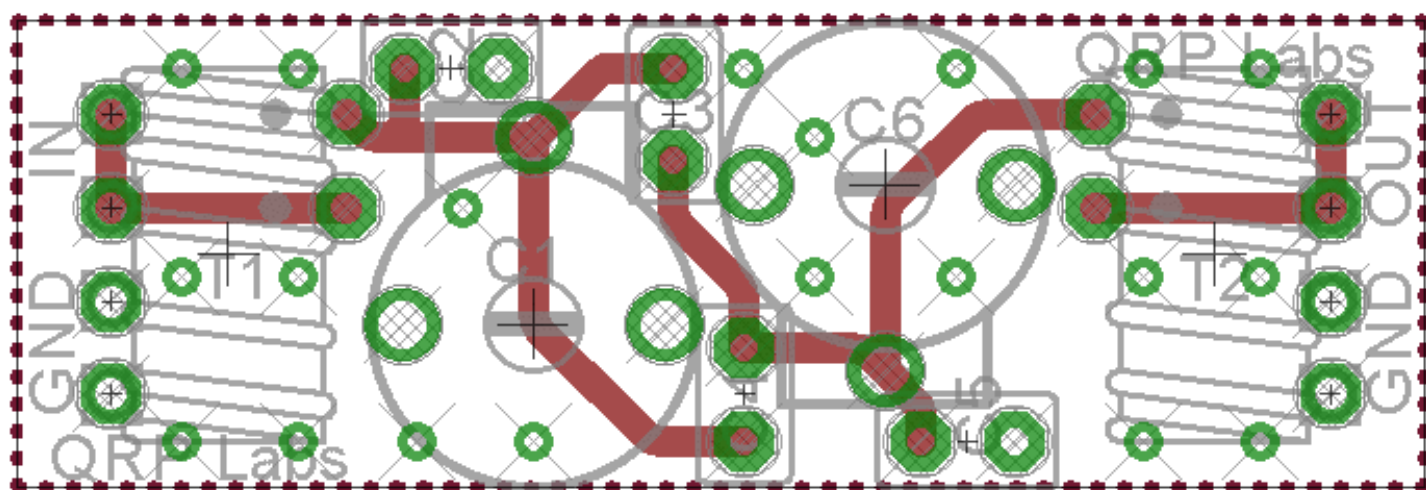

4.2 Toroid winding

IMPORTANT! The lower bands (40, 60, 80 and 160m) filters need to be wound with more turns than the number specified in the parts list table. This is because for these low bands, you will certainly need to adjust the number of turns to get the filter centre frequency correct. It is easy to remove one turn. But very difficult to add one! To add one you have to solder on an additional piece of wire and things get messy. So start by winding 4 turns too many – and you can then easily remove them one by one until you hit the exact right centre frequency. E.g. for 80m, the table says 30 turns. Please wind 34 turns! See the section below regarding lower frequency band filter construction!

Winding the toroids is quite straightforward but does need to be done carefully. The supplied wire length is more than enough to wind both toroidal transformers. Divide each wire length into two pieces. The thin wire is intended for the main toroidal winding of each tuned circuit: the winding with the most number of turns. The thick wire is to be used for the second winding which couples energy into and out of the tuned circuits to the in/out connection pads.

It is a little tricky using the thick wire wound on top of the thin wire. The thick wire is harder to wind neatly too. On the other hand, the thick wire does hold everything more rigidly in place. The main motivation for supply of two kinds of wire was to make sure you do not mix up the wire endings. If you wish, you could use the thin wire for both windings of the transformers (there IS enough wire for this). In this assembly manual I am assuming that you will use the thin and thick wire.

It makes no difference electrically, which direction the toroids are wound in. However, T1 and T2 pad layouts on the PCB are a mirror image of each other. Therefore I recommend winding T1 and T2 in opposite directions, just so that the wires fit the PCB pads better.

The following photographs show the transformers for a 15m BPF, as an example.

The photograph (right) shows T1 and T2. This is just the start of the main inductor winding, using the thin wire. For the 15m BPF, there are 18 turns to wind. This photograph shows the first 2 turns. In each case, the start of the winding is the left wire. I left about 2cm of wire free.

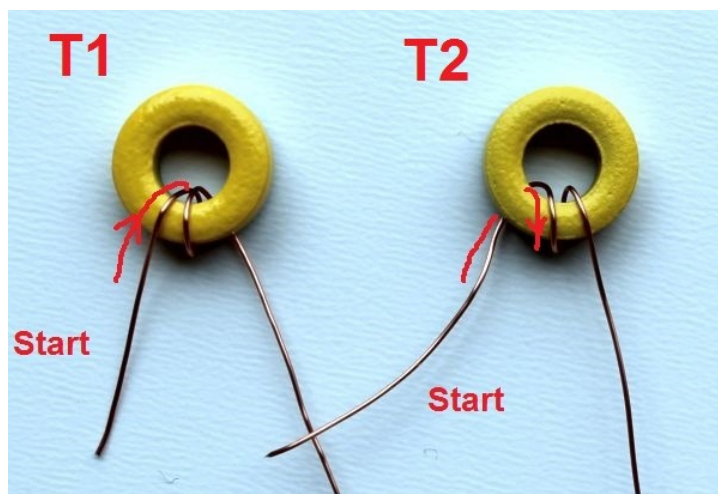

It should be clear that for the left toroid, the wire passes over the top of the toroid and through the hole, to start with. But for the toroid on the right, the wire passes behind the toroid and through the hole, towards us.

Remember that each time the wire goes through the centre of the toroid counts as one turn. You should aim to fill about 90% of the core (330-degrees). Leave a small gap between the winding ends, approx 10% of the core (30-degrees). This will give you some room to stretch or squeeze the turns, if you need to adjust the inductance later! Yes I know – the lower bands have so many turns, you cannot leave a gap. Fine!

When finished winding the 18 turns, the two toroids will look like this photograph.

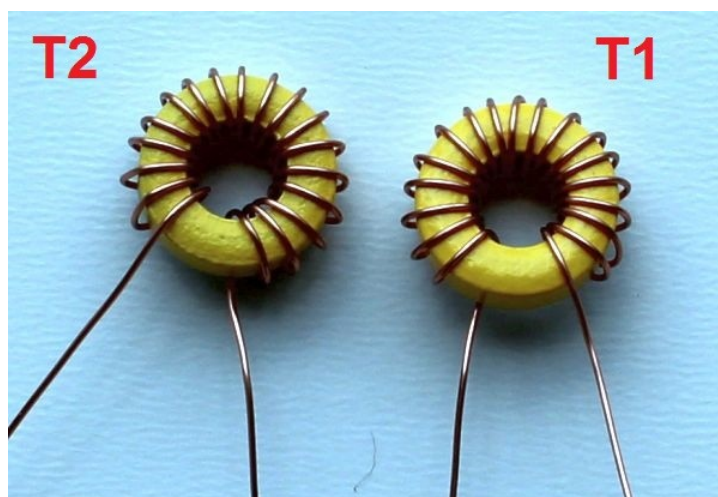

It is a good idea to try to wind the turns reasonably tightly and evenly spaced. It can take some practice! Don't worry if they aren't very neat.

Next, we add the second (short) winding, using the thicker wire. In the case of the 15m BPF photographed for the purposes of this section, this short winding has three turns. These three turns should be wound over the "cold" end of the main winding – this means, the end that will be grounded. So now you need to check the PCB and identify which of the two wires of your toroid, will go in which PCB holes. Then you will know which wire end is the "cold" end of the winding.

This diagram (right) shows where the toroid wires will be soldered. The yellow coloured lines indicate the toroid windings.

The ground ends of the toroidal transformer windings are going to be soldered directly to the header pin pads. Be sure to pay attention to where the thin wire (main winding, most turns) goes – always next to the board edge. The thick wire is the shorter winding, connected to IN (for T1) and OUT

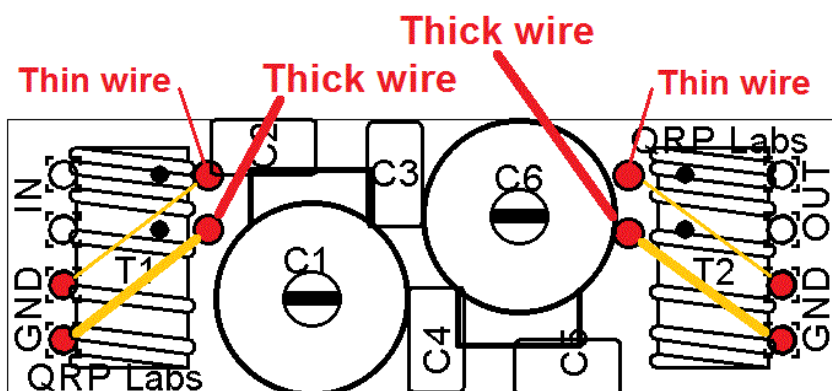

(for T2). The other ends of the toroidal transformer windings are both connected to ground pins (“GND”) so it does not matter which is the thin wire and which is the thick wire.

If you have wound the T1 and T2 main windings in opposite (mirror) directions, then you should find that the wire ends line up with the thin wire holes of T1 and T2, as shown in the diagram.

Now start winding the second winding of the transformer. The wire must be wound in the same direction as the main winding! Here the 15m band transformer is shown. The “cold” end of the toroid has been identified as the thin wire on the bottom left. The thick wire now “follows” the thin wire in the same direction. The start of the winding is the thick wire and at the bottom left of the picture. The thick wire is wound on TOP of the thin wire winding.



The photo (right) shows the completed second winding (thick wire). There are THREE turns in the 15m BPF. **Check the number of turns required, for the band you are building (see parts list).** Remember that each time the wire passes through the central hole of the toroid, counts as one turn.

Now is a good time to mention again, that this is very difficult to make neat and tidy. Ideally all the turns are evenly spaced, and the thick second wire winding exactly overlaps the main (thin wire) winding. I know, I’ve seen the photographs on the internet too, there are some people who are capable of winding toroids that look unbelievably perfect, like a robot made them. But for the rest of us mere mortals, we have to accept we aren’t capable of such a work of art. The good news for us, is that the electrons don’t care much! Our filter is still going to work just fine!



Below left: the completed pair of 15m band toroidal transformers T1 and T2. Note how they are a mirror image of each other, so that they neatly fit the board. As I said, this is not strictly necessary – it just makes things easier and neater!

Below right: two toroids for the 80m filter. The left toroid only has the main winding. The right one has both windings. Notice how it isn’t possible to leave the recommended 30-degree gap in the winding. You can fit up to 35 turns of this wire thickness on a T37-6 core, with no gap. Also notice how the right second (thick

wire) winding isn't so neat anymore. Don't worry about it! Just to emphasis the point – this photograph is taken on my workbench, with all the solder burns and scratches etc. Not the nice white board where the 15m BPF transformers are photographed (left)! Real life.

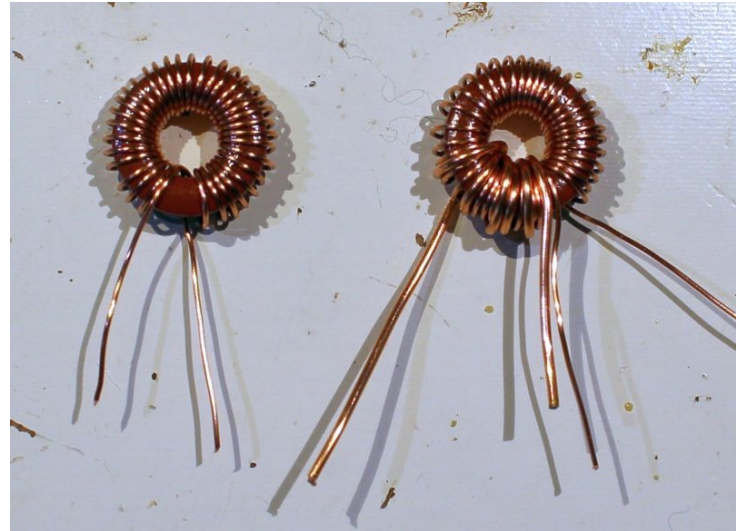
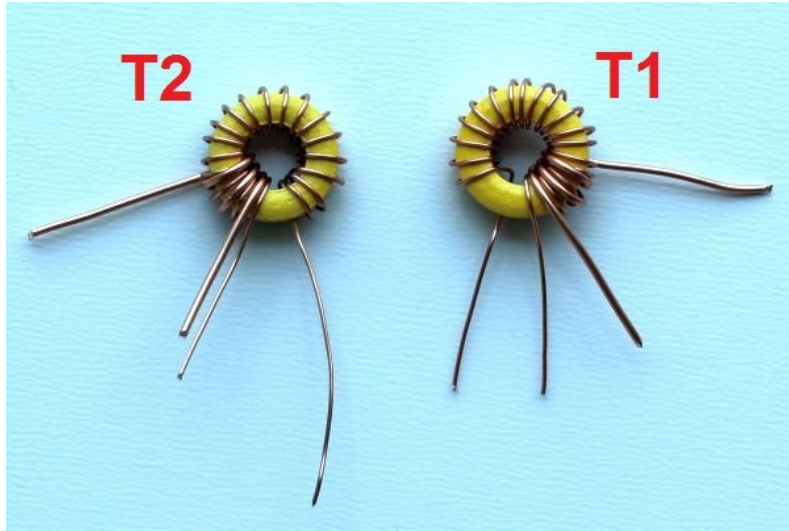

The enamelled wire needs to be stripped off in order to solder properly to the copper inside. You can remove the enamel by scraping the enamel off then tinning the wire with solder. As an alternative to scraping the enamel off, my preferred method is to trim the wire ends back to 2mm below the board, then solder them with a small blob of solder. I hold the iron on the joint for 10 seconds. After about 7-8 seconds you can see the enamel bubble away and the solder sticks to the copper, making a good joint with the board.

For the wires that will be soldered to the top of the header pins, you should NOT do the 10 seconds method on the joint itself! In 10 seconds you may melt the plastic of the header pins! It is better to tin the wire ends by holding the wire end alone in a molten blob of solder on the iron tip, for a few seconds. Then you can make a fast soldering job on the actual joint on the header pin itself, without risk of melting the plastic.

4.3 Trimmer capacitor details

The trimmer capacitors supplied in the kit have a minimum-maximum value of approximately 3-30pF. One set of capacitor plates is fixed; the other is attached to the adjustment screw and movable. The amount of overlap of the plates determines the capacitance.

In the PCB layout I made sure that the trimmer capacitor plates that are fixed to the central adjustment screw are the grounded side of the trimmer capacitor. This means that you can easily adjust the capacitor using an ordinary metal screwdriver without significantly affecting the capacitance or the filter response etc.

The nice thing about these trimmer capacitors is that you can easily visually see approximately what the capacitance is set to. In the following sections on adjustment of the filters, I will refer to the trimmer capacitors being “open” or minimum (3pF, minimum capacitance), “closed” or maximum (30pF, maximum capacitance), or half-way.

Minimum capacitance (“open”). You can see that the plates of the trimmer capacitors have no overlap.

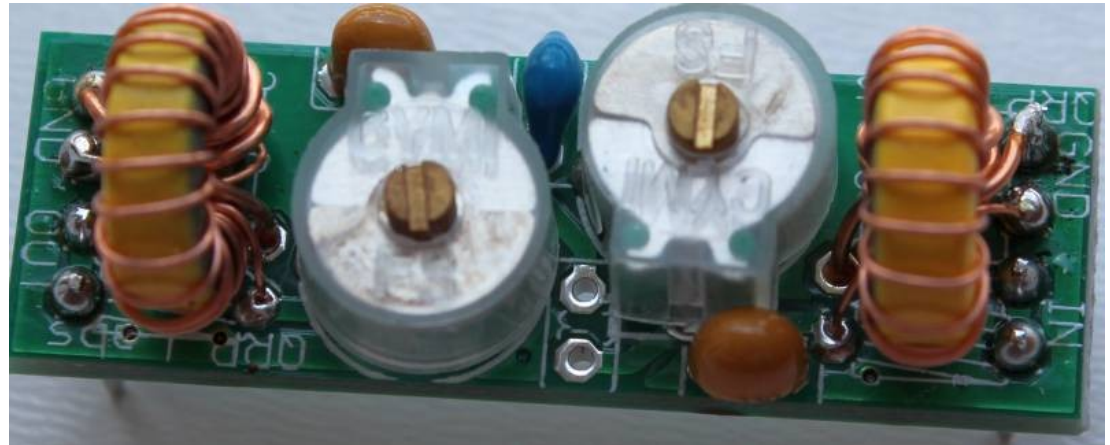

Maximum capacitance (“closed”). You can see that the plates of the trimmer capacitors overlap each other completely.

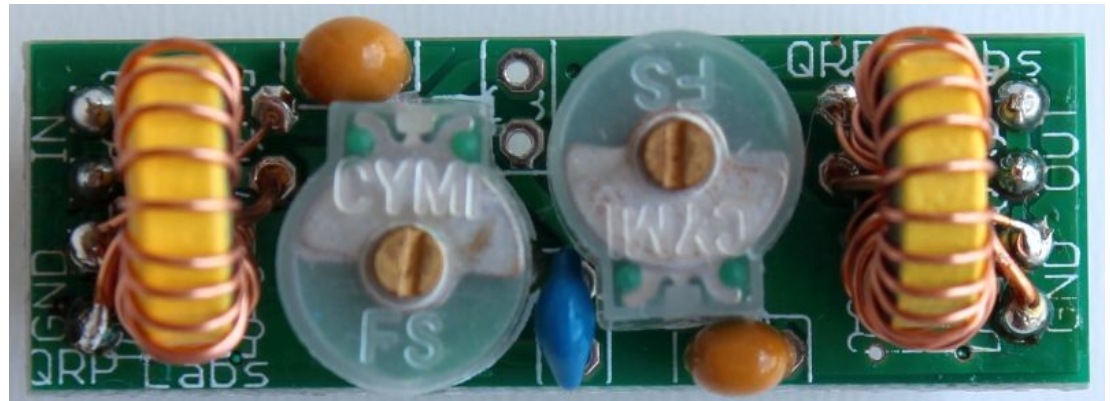

Half-way state – the plates of the capacitors half overlap.

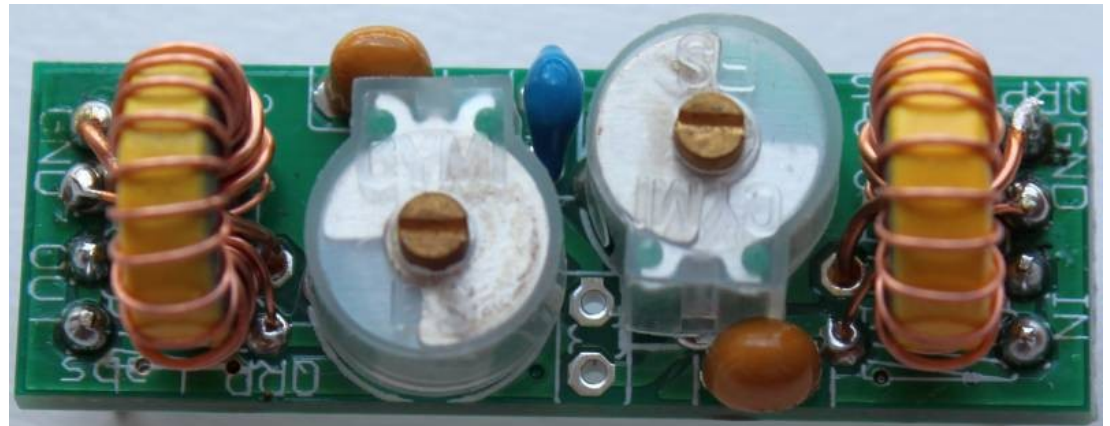

4.4 First steps of assembly (all bands)

1) Trimmer capacitors C1, C6

First install the two trimmer capacitors. The pins probably need to be straightened a little to fit in the holes. Note how the trimmer capacitors are fitted in mirror image to each other. The silkscreen legend on the board shows the orientation.

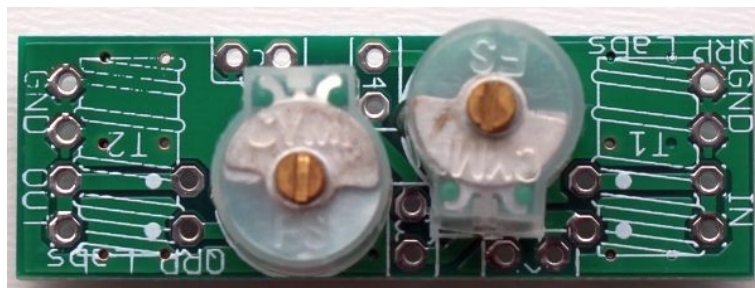

When soldering the pins, try to be FAST. You don't want to risk melting the plastic of the capacitor insulation and body.

The trimmer capacitor pins are quite long. If you intend to use these band pass filter modules plugged into something like the QRP Labs relay-switched filter kit, then it may be a good idea to cut off the excess pin length after soldering, to avoid the conflict with the top of the relays.

2) Fixed capacitors C2, C3, C4, C5

Now install the fixed capacitors. Check the value carefully before soldering, using a magnifying glass or jeweller's loupe. The value printed on the capacitor body is shown in the parts list for your band (see section 2 above). Be careful – for example, a capacitor labelled “100” is not 100pF! It is 10pF! The marking means digits 1 and 0 followed by 0 zeros. Which means 10pF!

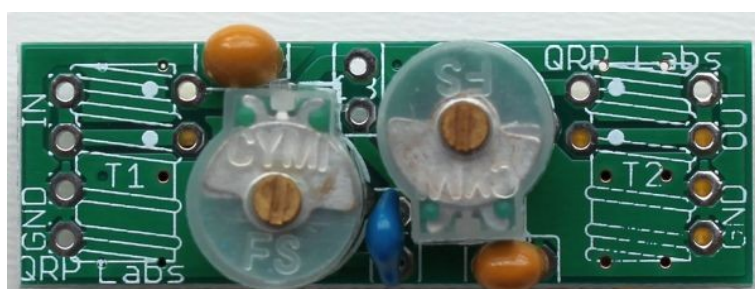

The coupling capacitor between the two tuned circuits is made up of two positions on the board, C3 and C4. This is because for some bands, the capacitance is made up of two smaller capacitors in parallel. In the photograph, the coupling capacitor is the blue one in this case (this is the 15m filter).

I suggest reading the discussion on filter bandwidth before fitting the coupling capacitor C3/C4. You may wish to substitute a larger value capacitor for wider bandwidth, or a smaller value capacitor for narrower bandwidth.

For the 40m, 60m, 80m and 160m, you are going to need to experiment with the number of toroid turns. This is easier if you do NOT install the top (“hot”) end of the main toroid winding in the PCB hole to start with. It is easier if you do not cut off the excess wire lengths from the C2 and C5 capacitors. You can then temporarily solder the toroid winding wire end to the capacitor lead. **Please read the special notes below on assembling the 40-160m filters first!**

3) Install pin headers

Install the 4-way pin headers. Be careful to make sure that they are straight. One way to do this, if you have a relay-switched filter kit for example, is to plug the headers into the matching sockets, then solder the pins on the top side of the PCB. This will ensure good alignment! A breadboard would work, too. Please solder the pins FAST if possible, to avoid risk of melting the pin header plastic!

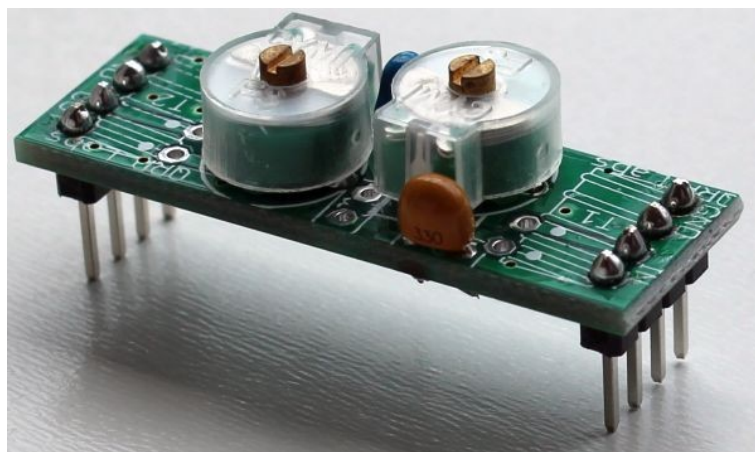

4.4 Assembly of 30m, 20m, 17m, 15m, 12m and 10m filters

This section describes the assembly and adjustment of these higher frequency filters. In these filters, the centre frequency is primarily tuned by using the trimmer capacitor. They are easier to adjust than the lower band filters (40m and below).

1) Install transformers T1 and T2

Again please refer to the diagram (right). Make sure the right wires are in the right holes! The thin wire ends are in the holes nearest to the board edge!

Insert the “hot” (non-grounded) wire ends of the transformer windings in the appropriate holes in the PCB (see right).

I suggest soldering the grounded ends of the wires first. This holds the toroid in place conveniently, making it easier to solder the “hot” ends. You can also pull the wires using pliers to make everything tight.

The grounded ends (“GND”) are soldered directly onto the top of the header pins. This method was dictated by the PCB size requirements (to be compatible with the QRP Labs relay-switched filter kit). It’s actually very easy to solder to these pins, easier than soldering the wire in a PCB hole.

Tin the wire end first, before soldering it to the PCB header pin. Don’t be tempted to use the 10-second burn method to remove the enamel, while soldering to the header pin – this could melt the black header plastic on the other side of the PCB. Instead, hold the wire end in a blob of molten solder for some seconds until you can see that the enamel is burnt away and the wire is tinned, ready for soldering.

As I have mentioned a couple of times already, but will say it again to reinforce the point... it is very difficult to keep it all looking perfectly neat. Don’t worry about it! The electrons are a lot less fussy than you think.

Right: here’s another construction method that I found also works well. Instead of soldering the thick wire in the PCB hole, solder it directly to the “In” and “Out” header pins. It’s easier and it works fine!

Finally, cut the wires on the underside of the board, the “hot” end of the transformer windings, and solder them. This will be the thin wire (main winding), and also the thick wire (coupling winding) if you decide to solder it in the hole, rather than direct to the pins.

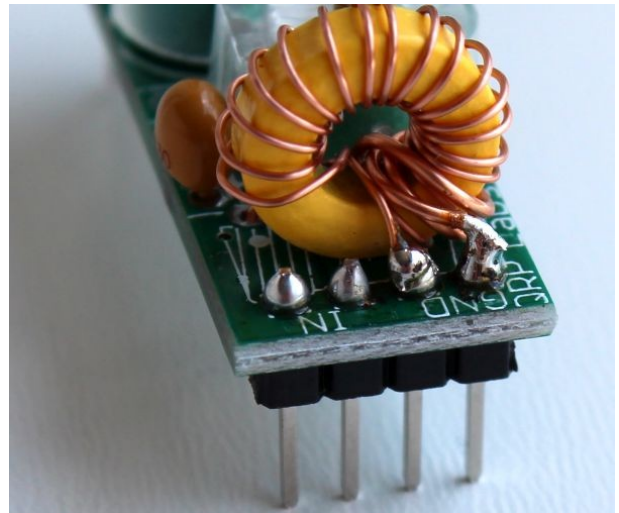
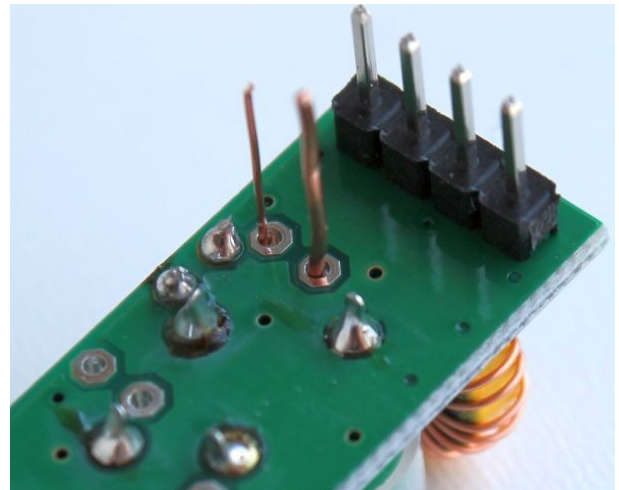
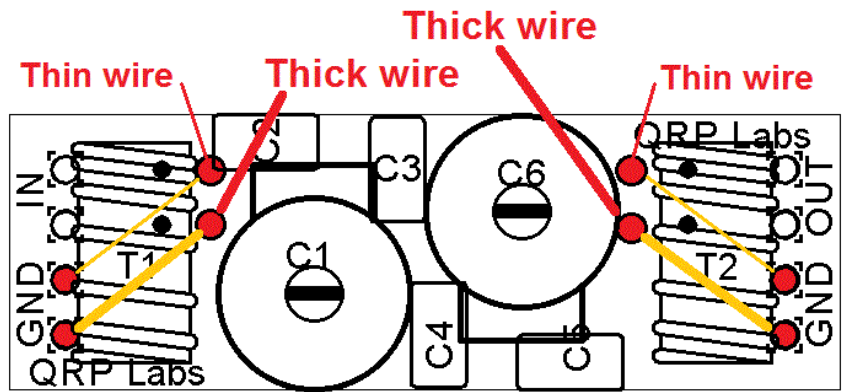

2) Check continuity!

A common cause of problems is no connection to the copper wire, due to the enamel insulation not being properly scraped/burnt off! It is important (and very easy) to check this now, using your Digital Voltmeter. Just set it to measure resistance, and check for continuity (zero ohms). You should hold the negative probe on one of the ground pins, and hold the positive probe to each of the points labelled 1-4 in this diagram. You should measure 0 ohms in every case! If you do not – then it means you have either connected something wrongly, or have not properly scraped/burnt off the enamel wire insulation! So go back and check everything!

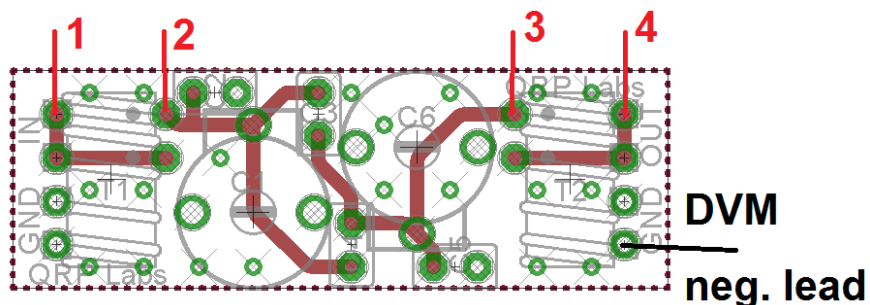

3) Adjustment

Adjustment of the trimmer capacitors is necessary to move the centre frequency of the filter to the middle of the amateur band (or other desired centre frequency).

If you have a spectrum analyser with tracking generator, or a network analyser, then of course you (lucky constructor!) can connect your filter to this and make a very convenient adjustment, watching the shape of the filter response and the centre frequency on the screen.

If not, then adjustment of the filter is best done by tuning the trimmer capacitors for maximum response of the filter at the required centre frequency. You can do this for example, by inserting the filter in the front end of a radio receiver, and tuning to a strong frequency somewhere near the centre of the band. Then adjust the trimmer capacitors for maximum signal strength. You will need to re-adjust each trimmer capacitor in turn, a few times, making slight adjustments. This method works well. You can do it by ear listening to the receiver's audio output, or the radio's S-meter, or if you use a PC with audio software or SDR software then you may be able to read the signal strength on screen.

IMPORTANT: when you have tuned for maximum signal strength, if either of the trimmer capacitors are at their minimum or maximum position (refer to section 4.3 above), then it means that you have run out of adjustment ability. The inductance of the toroid winding is incorrect! You need to alter it. With these higher frequency filters, you can normally fix things by squeezing or stretching the turns of the toroid.

If a trimmer capacitor is at the minimum (open) position, it means that the inductance of the toroid next to it is too large. You could remove one turn but you probably do not need to do this. You can space the turns out to cover 100% of the core, this will reduce the inductance slightly. Then try the trimmer capacitor adjustment again.

If a trimmer capacitor is at the maximum (closed) position, it means that the inductance of the toroid next to it is too small. You could add one turn but you probably do not need to do this. You can squeeze turns together to cover less of the core, this will increase the inductance slightly. Then try the trimmer capacitor adjustment again.

For example, with an inductance meter and 25 turns on a T37-6 toroid covering 90% of the toroidal core (330-degrees), I measured 2.11uH. If I spaced out the turns to cover 100% of the core, the inductance decreased to 2.02uH. On the other hand if I squeezed together the turns to cover only 75% of the core, the inductance measurement increased to 2.26uH. So you can see that squeezing/stretching the turns can result in inductance change of several % (typically 5 or 10%) and this is probably enough to fix your adjustment problem.

4.5 Assembly of 40m, 60m, 80m and 160m filters

This section describes the assembly and adjustment of these lower frequency filters, using 80m for the photographs. In these filters, the centre frequency is primarily tuned by adjustment of the number of toroid turns. The trimmer capacitor makes only slight changes. **Wind the toroid main winding with 4 turns more than the number specified in the parts list for your band!**

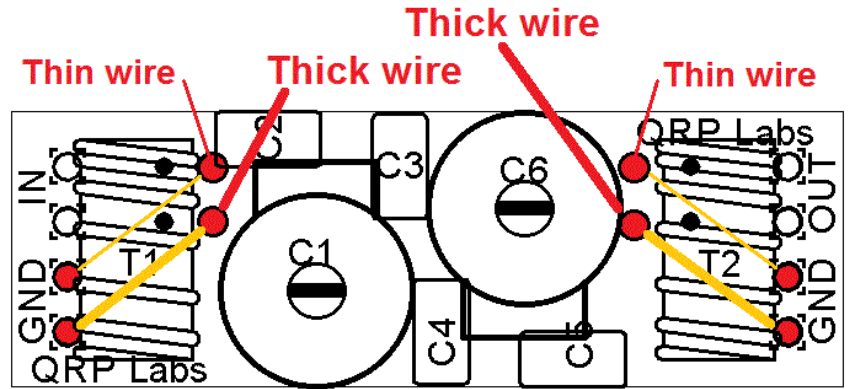

1) Install transformers T1 and T2

Again please refer to the diagram (right). Make sure the right wires are in the right holes! The thin wire ends are in the holes nearest to the board edge!

Here as I mentioned in section 4.4 step 2, you can leave one of the wires of each capacitor C2 and C5 un-cut temporarily.

You can use these to temporarily solder the “hot” (non-Grounded) end of the main transformer winding to the capacitor wire, while you experiment to find the right number of toroid turns (see adjustment section, below).

You can also see how this looks in the workbench photo (see right).

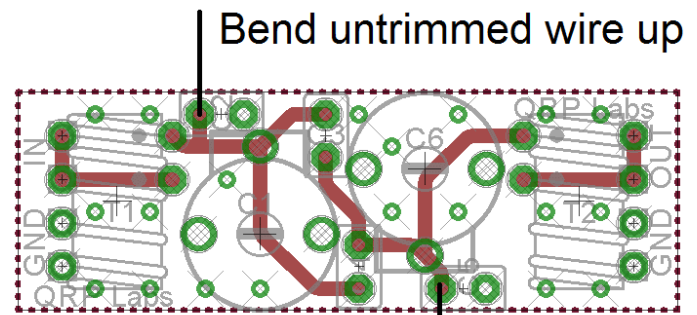

Bend untrimmed wire up

Take care which of the wires to leave un-cut and use for the temporary connection of the main transformer winding ends! The capacitor connections are NOT symmetrical (not a mirror image). If you hold the PCB as shown in the photograph, you want the **left** wire of both C2 and C5. It is NOT necessarily the wire closest to the toroid!

Soldering the grounded ends of the wires first. This holds the toroid in place conveniently, making it easier to solder the “hot” ends and deal with the experimental determination of the main winding. Later you can pull the wires using pliers to make everything tight.

The grounded ends (“GND”) are soldered directly onto the top of the header pins. This method was dictated by the PCB size requirements (to be compatible with the QRP Labs relay-switched filter kit). It’s actually very easy to solder to these pins, easier than soldering the wire in a PCB hole.

Tin the wire end first, before soldering it to the PCB header pin. Don’t be tempted to use the 10-second burn method to remove the enamel, while soldering to the header pin – this could melt the black header plastic on the other side of the PCB. Instead, hold the

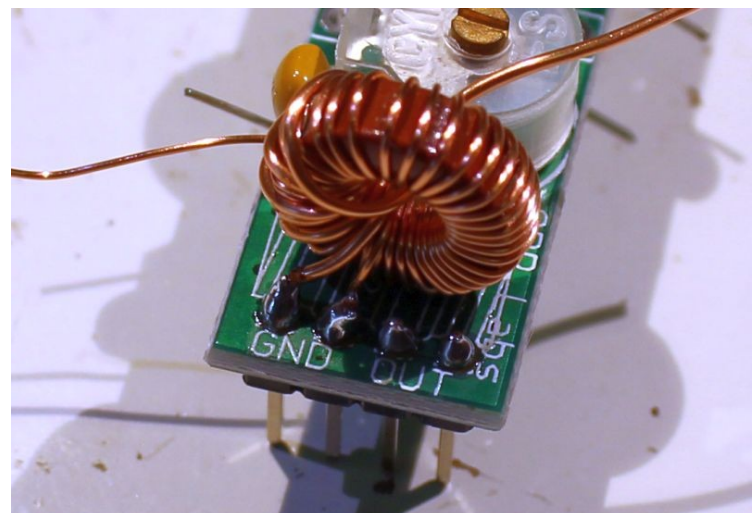
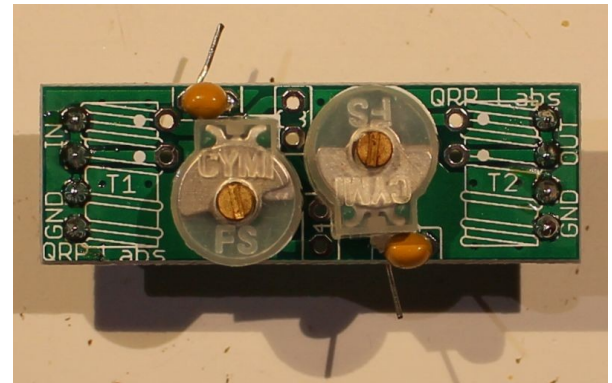

wire end in a blob of molten solder for some seconds until you can see that the enamel is burnt away and the wire is tinned, ready for soldering.

As I have mentioned a couple of times already, but will say it again to reinforce the point... it is very difficult to keep it all looking perfectly neat. Don't worry about it! The electrons are a lot less fussy than you think.

Solder the thick wire (short winding) in its PCB hole, or to the header pin. Right: the method of soldering directly to the header pin also works well, instead of soldering the thick wire in the PCB hole. It's easier and it works fine!



Do not solder the “hot” (non-ground) end of the main toroid windings yet! This will be done temporarily first before installation in the PCB hole – see “Adjustment” step, below.

2) Check continuity!

A common cause of problems is no connection to the copper wire, due to the enamel insulation not being properly scraped/burnt off! It is important (and very easy) to check this now, using your Digital Voltmeter. Just set it to measure resistance, and check for continuity (zero ohms). At this stage, check the resistance between IN-GND, and OUT-GND pins. The resistance should be 0 ohms (continuity). Also check the resistance between Gnd and each of the un-connected “hot” (non-ground) main wire endings.

3) Adjustment

Adjustment of the toroid inductances is necessary to move the centre frequency of the filter to the middle of the amateur band (or other desired centre frequency). Unfortunately because the 30pF trimmer capacitor is only a small proportion of the fixed capacitor, the range of adjustment is quite small. It is therefore necessary to experiment with the number of turns on the toroid, to get the inductance correct for the target centre frequency.

If you have a spectrum analyser with tracking generator, or a network analyser, then of course you (lucky constructor!) can connect your filter to this and make the adjustment conveniently, watching the shape of the filter response and the centre frequency on the screen.

If not, then adjustment of the filter is best done by tuning for maximum response of the filter at the required centre frequency. You can do this for example, by inserting the filter in the front end of a radio receiver, and tuning to a strong frequency somewhere near the centre of the band. Then we must adjust the number of toroid wire turns for maximum signal strength. You can do it by ear, listening to the receiver's audio output, or the radio's S-meter, or if you use a PC with audio software or SDR software then you may be able to read the signal strength on screen.

As I mentioned previously, you should wind 4 turns more than the number specified in the parts list table for your band. This is because it is much easier to remove one turn at a time, than it is to add one turn at a time! For example, if the parts list says 30 turns, then wind 34 turns!

When you first test the filter, with 4 turns more on the toroids' main winding than the number specified in the parts list, you will find that the filter's centre frequency is too low. Probably the two tuned circuits aren't properly tuned to match each other, either.

In order to adjust the filter, I found the following to be the best method. The method is similar if you are using a spectrum analyser or network analyser for the adjustment, or a receiver observing the signal strength.

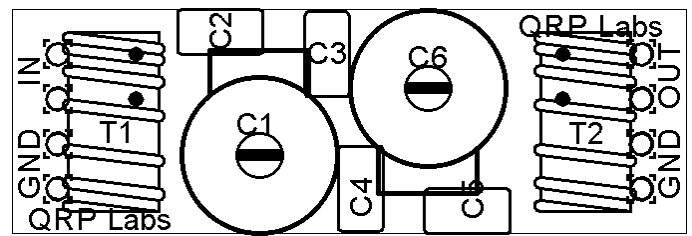

Temporarily solder the “hot” winding ends of T1 and T2 to the un-cut wires sticking out of C2 and C5

respectively. Do NOT solder the winding ends into the PCB pad holes yet! It is very difficult to remove and adjust the number of wire turns, once the wire end is soldered in place!

Choose a test frequency in the centre of the band, or tune your receiver with the band pass filter in the front end, to a strong signal in the middle of the band. Now adjust the trimmer C1 to the maximum capacitance (“closed”). Observe the signal strength. Next change it gradually to the minimum capacitance (“open”). Initially, the signal strength will increase steadily as you decrease the trimmer capacitance to the full open (minimum capacitance) position. This means you need to REMOVE one turn from the main winding T1. So un-solder the temporary connection to C2’s un-cut wire end, remove one turn from the toroid, and solder the winding wire end to C2 again. There is no need to cut the few excess cm of wire off the winding yet.

Now, repeat the same thing with C6 and T2. Again you will almost certainly find it necessary to remove a turn from T2 as well.

Repeat this over and over again, removing one turn from T1 then one turn from T2, as you monitor the filter shape and centre frequency (if you have a spectrum analyser or network analyser), or monitor the signal strength of a strong signal in the middle of the band. After removing a turn from T1 and T2, you should try adjusting both C1 and C6. If peak signal strength at the desired centre frequency occurs with C1 “open” (minimum capacitance) and C6 “closed” (maximum capacitance) – or the other way around – then it is necessary to remove a turn from T1, and not T2 (or the other way around). It is often necessary to remove more turns from one transformer or the other, because you could not make the windings exactly the same inductance. The toroidal core material has some variation too from one component to the next.

When you have removed one turn and you decide to remove another, you can trim a few cm off the wire length of the main winding, because at this stage you have determined that you definitely don’t need those few cm.

At some point you should find that the signal strength peak is not at one end of the trimmer capacitance range or the other – but somewhere in the middle. Then you will know that you have the right number of inductor turns. You should not need to remove more than 4 or 5 turns, to peak the filter response on your desired centre frequency.

This is a tricky adjustment and you might find that you miss that trimmer capacitance peak. You might find that removing the turn you just took away actually reduces the signal strength, not increases it. In that case, you can put back that turn and then leave it alone.

Of course all this is easier with a spectrum analyser with tracking generator, or a network analyser. But it is still possible with a receiver and the observed signal strength method.

Although a tricky adjustment, the good news is that even if you find it hard to make a perfect adjustment, the filter response on these low bands will still probably be quite reasonable and usable.

When you have decided the number of turns, you can disconnect the temporary C2 and C5 connections, and cut their wires flush to the board as usual. Then insert the main winding wire end (“hot” end) into the PCB hole and make the permanent connection.

4.6 Some specific notes for each bands

The following notes and observations may be of use, for specific bands.

10m band filter

The parts list specifies a 2pF coupling capacitor. I found that the bandwidth is 3.01MHz and insertion loss 2.52dB. If using a 3pF capacitor, the bandwidth increased to 3.72MHz and the insertion loss dropped to 1.37dB.

12m band filter

My measurements of coupling capacitor vs insertion loss and bandwidth are shown in this table.

Capacitor	Bandwidth	Insertion loss
4pF	3.46MHz	1.23dB
3pF	2.61MHz	1.17dB
2.5pF	2.54MHz	1.35dB
2pF	2.12MHz	1.80dB

Chosen value: 3pF

15m band filter

With a 5pF coupling capacitor there was a classic double-hump over-coupled response curve. The bandwidth was too large, 2.92MHz; the insertion loss was under 1dB, at one of the two peaks.

With a 4pF capacitor the bandwidth was 2.57MHz and insertion loss still about 1dB.

With a 3pF capacitor the bandwidth was 1.54MHz and insertion loss about 1.3dB. This 3pF capacitor was chosen for the final recommended parts list value.

17m band filter

No particular observations.

20m band filter

No particular observations.

30m band filter

No particular observations.

40m band filter

My measurements of coupling capacitor vs insertion loss and bandwidth are shown in this table.

Capacitor	Bandwidth	Insertion loss
15pF	0.779MHz	1.53dB
12pF	0.643MHz	1.53dB
10pF	0.550MHz	1.68dB

Chosen value: 15pF

Note: one transformer required 29 turns on the main winding, one required 30 turns.

60m band filter

10pF coupling capacitor resulted in 400kHz bandwidth and 3.15dB of insertion loss. 15pF (10pF and 5pF in parallel) resulted in 486kHz bandwidth and 1.52dB insertion loss. 15pF is the chosen value for the kit.

These two response photographs illustrate the close-in response when (left) both trimmer capacitors are set to minimum and (right) when one capacitor is minimum and the other maximum, to offset the resonances of the two tuned circuits. The offset case results in a wider, flat bandpass response, and slightly higher insertion loss. It is a good example of theory in practice.

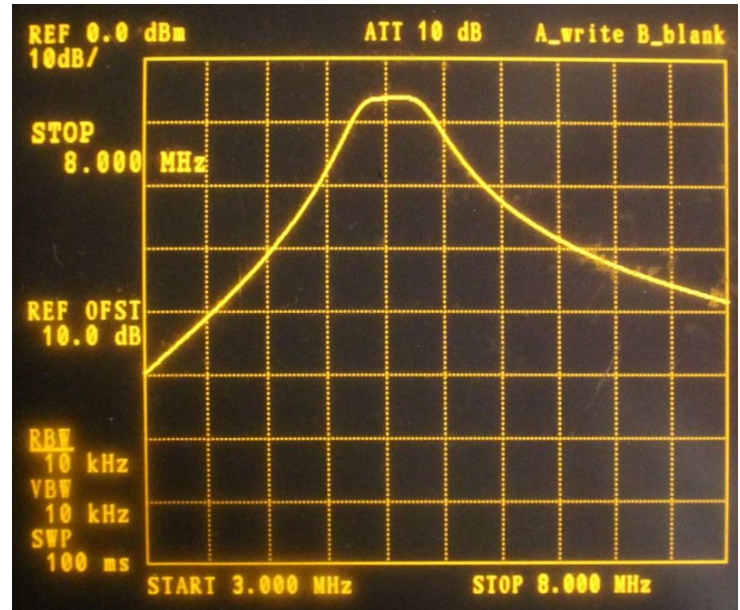
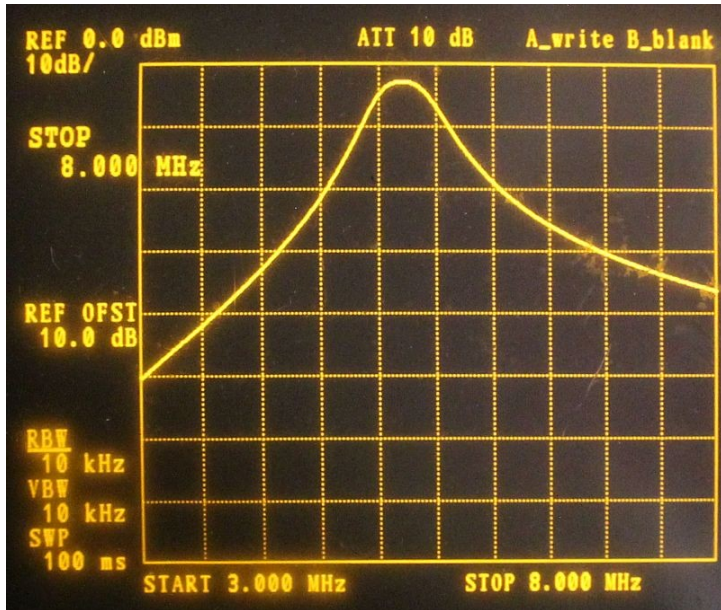

80m band filter

My measurements of coupling capacitor vs insertion loss and bandwidth are shown in this table.

Capacitor	Bandwidth	Insertion loss
47pF	465kHz	1.27dB
42pF	428kHz	1.12dB
32pF	352kHz	1.00dB
22pF	246kHz	2.27dB
12pF	197kHz	5.45dB

Chosen value: 47pF.

Initial centre frequency with 34 turns on the main windings was 3.2MHz.

Removal of two turns from each side resulted in 3.386MHz centre frequency.

Removal of one more turn from each side resulted in 3.547MHz centre frequency.

Final removal of one more turn from each side resulted in 3.649MHz centre frequency.

You can see that each turn removed shifts the centre frequency by something like 100kHz (very approximately). In this case the number of turns was therefore reduced equally from both transformers, from 34 turns to 30 turns. It would not necessarily always be the case that the reduction is equal on both transformers.

160m band filter

It was noted that the difference in centre frequency obtained by turning both trimmer capacitors from “open” (minimum) to “closed” (maximum) was only 31kHz.

Initially 44 turns were wound on the T50-2 toroidal cores. It was necessary to remove 2 turns from each transformer to reach a centre frequency of 1.906MHz.

My measurements of coupling capacitor vs insertion loss and bandwidth are shown in this table.

Capacitor	Bandwidth	Insertion loss
78pF	231kHz	1.17dB
68pF	226kHz	1.25dB
56pF	180kHz	1.15dB

Chosen value: 68pF.

Capacitors: The 820pF capacitor supplied for capacitors C2 and C5 (printed value “821”), may have 5mm pin spacing. In this case, it is necessary to straighten out the wires, to make them fit the 2.54mm (0.1-inch) spaced PCB holes.

The photograph shows the supplied capacitor (left of photo) and after bending the wires to 0.1-inch spacing (right of photo).

5. Measured filter characteristics

For reference, the following chart shows the measured performance of the constructed filter prototypes, which used the component values specified in the table in section 2. Insertion losses measured are adjusted for the calibration of the instrument.

<u>Band</u>	<u>Centre frequency</u>	<u>Bandwidth</u>	<u>Insertion</u>
160m	1.867MHz	0.226MHz	-1.45dB
80m	3.540MHz	0.465MHz	-1.27dB
60m	5.243MHz	0.486MHz	-1.48dB
40m	7.207MHz	0.793MHz	-1.53dB
30m	9.891MHz	1.15MHz	-1.35dB
20m	14.15MHz	1.44MHz	-1.75dB
17m	18.22MHz	1.63MHz	-1.95dB
15m	21.00MHz	1.538MHz	-1.10dB
12m	25.53MHz	2.87MHz	-1.55dB
10m	28.99MHz	3.01MHz	-2.52dB

The following photographs of the spectrum analyser screen show the filter responses.

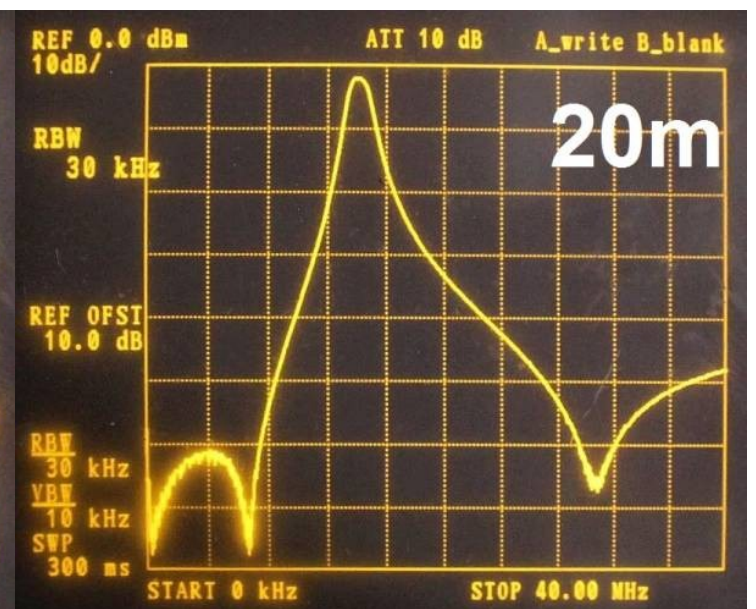
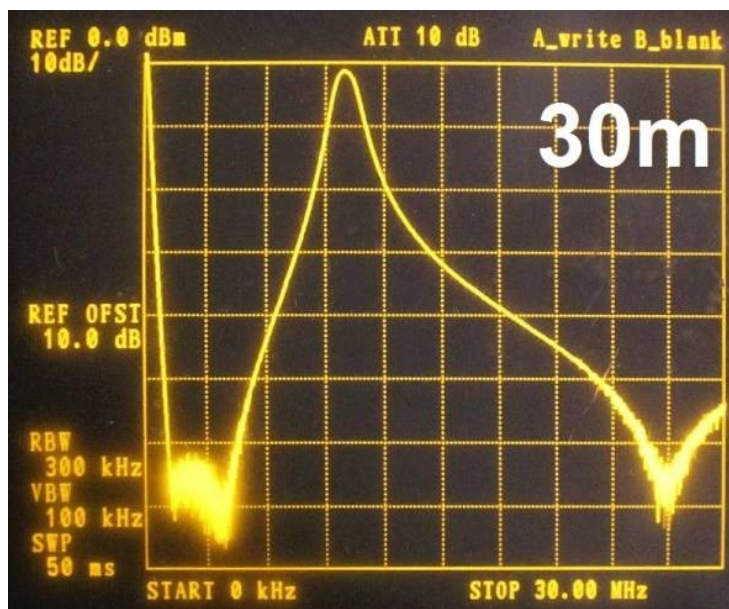
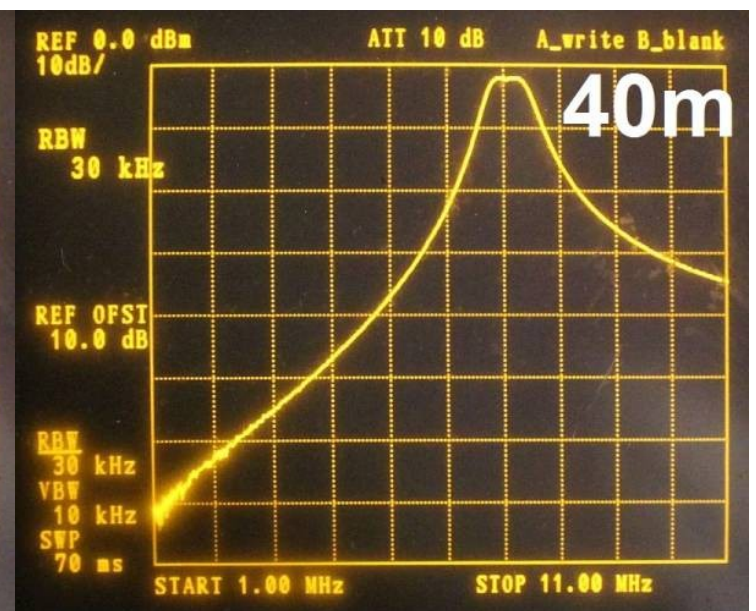
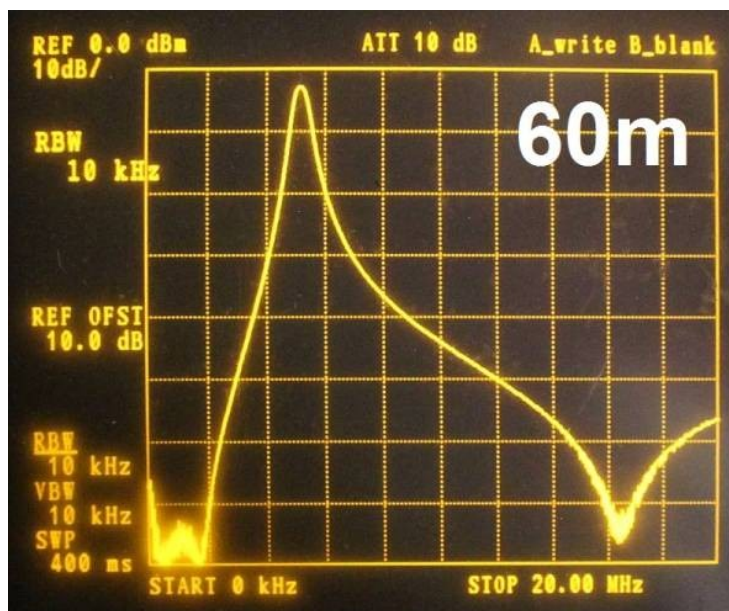
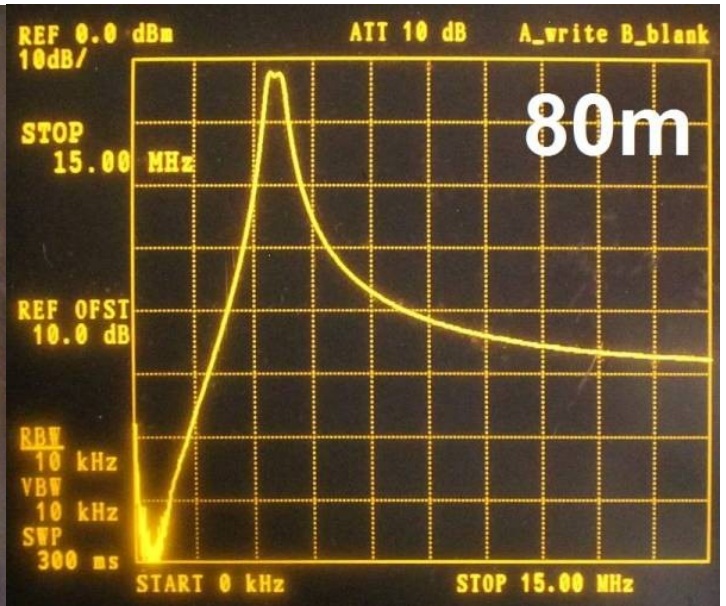
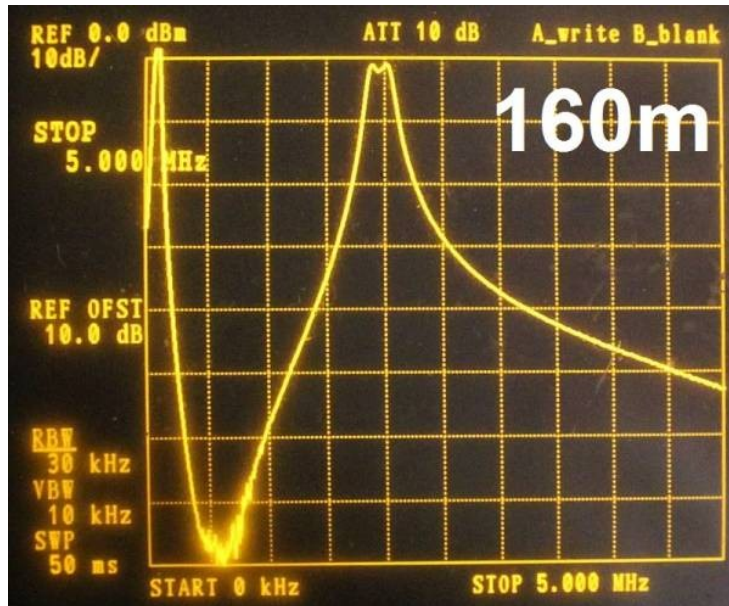

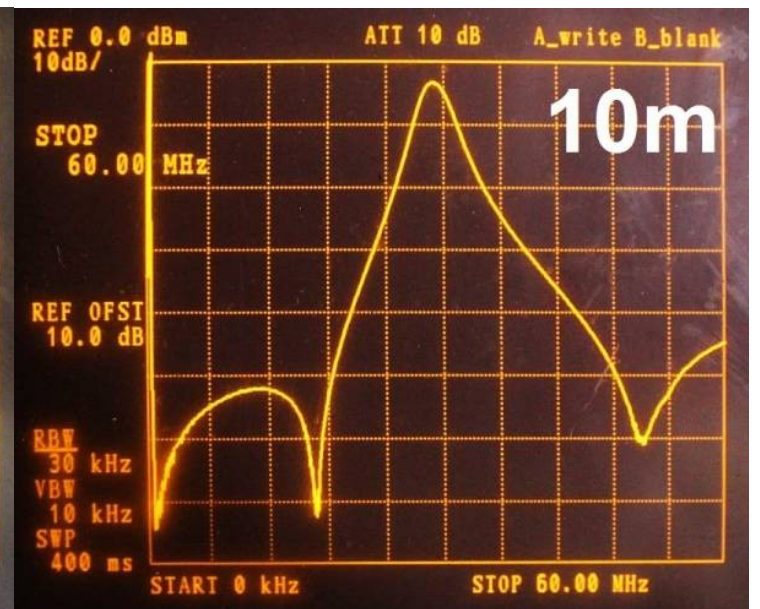
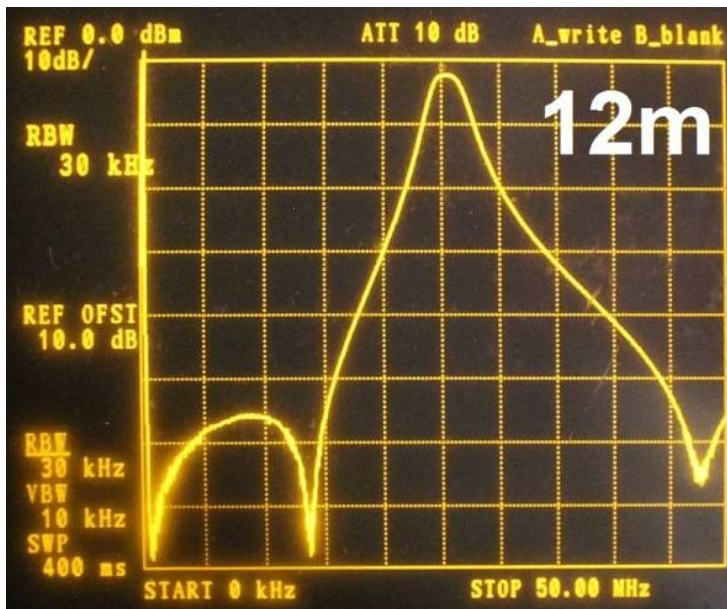
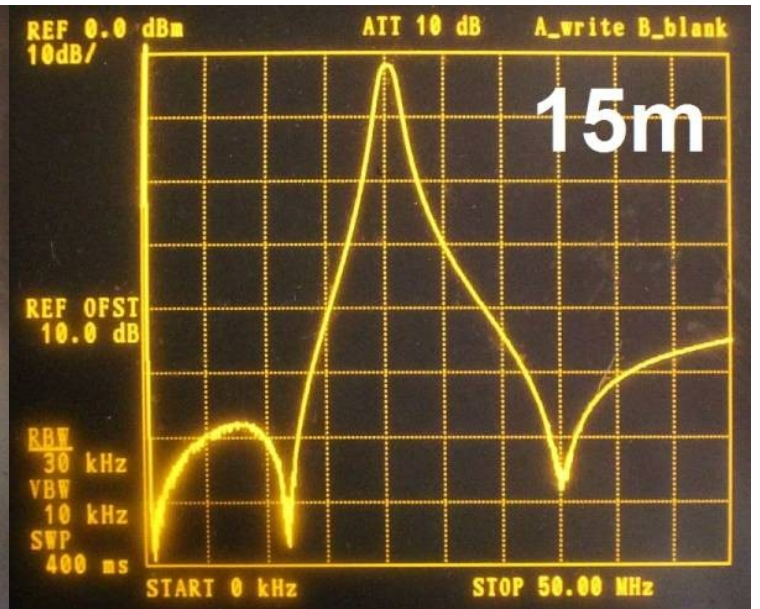

6. Resources

Please see the kit page <http://qrp-labs.com/bpokit> for information and latest updates.

7. Document history

2 26-Sep-2016

- Corrected typo and grammar on page 5
- Added T1 and T2 labels to some of the photos (page 5, 6)

3. 26-May-2021

- Update for 20m BPF which can contain either 56pF or 68pF capacitors

4. 08-Feb-2023

- Correct type (LPF should be BPF) on first page